

CATALOGUE

Walcom®

2018.2019











WWW.WALMEC.COM

EN

INDEX

SPRAY GUNS		FILTER SERIES	
Genesi Carbonio HTE base	6	FSRD 4 - FSRD 3 - FSRD 2	51
Genesi Carbonio HTE clear	8	FSRD - FCA - PFR	52
Genesi Carbonio HVLP	10	ESR - THK - FILTER SPARE PARTS	53
Genesi Carbonio GEO	12	THERMODRY TECHNOLOGY	
Genesi Top Line HTE - HVLP - GEO	16	TD ³ PRO - TD ¹ PRO - THT	56
Slim HTE - HTE SR - HVLP - HD system	20	THK - THJ - THJ/R - THS	57
EGO HTE - HVLP & Grafo System	26	THRC - THTest - THC	58
AUTOMATIC SPRAY GUNS		ECODRY	
MATIK HTE 3/4 - HVLP 3/4 - GEO 3/4	28	Ecodry	59
MAIN SPRAY GUN SPARE PARTS		Ecodry Light	59
Genesi Carbonio needle - nozzle - cap set	31	Air blower pro	59
Genesi Top Line needle - nozzle - cap set	31	Ecodry Stand	59
Slim needle - nozzle - cap set	31	SPRAY GUN CLEANER	
EGO needle - nozzle - cap set	31	Easy/S	61
MATIK needle - nozzle - cap set	31	Easy/W	61
Spare parts box Genesi Carbonio/Top Line - Slim - EGO	32	COMPRESSED AIR GUNS	
Genesi - Slim - EGO - MATIK gaskets kit	32	IM BODY	62
Cups	33	AS/FG	63
COUPLINGS AND PLUGS		PC/NS-FG	63
X300 U	37	IA/L-FG	63
X300	38	IA/LU-FG	63
X400	39	TS	63
PAINTING ACCESSORIES			
Various	40		
Hoses	48		

KEY OF THE SYMBOLS USED:

 body shop	 building	 touch-up	 decoration
 industry	 woodworking	 D.I.Y.	 paint type

 Spraygun weight is without cup and regulator.

COMPANY 3.0



A history of over 70 years of activity makes Walmec one of the more long living companies, not only in the pressurized air scenario, but also in the whole national territory.

This is source of great pride for us, because it show how far can a company go, if it puts customers' satisfaction as its first goal.

Behind all those years there the sacrifices of lot of people that have devoutly dedicated their time, passion, professionalism to our cause, there are ideas, chance but, above all, the strong will to never stop. Coming from all of us.

Today we need to look further more than ever.

Markets are growing, evolving, demanding.

Companies have to satisfy all of the needs they dictate, needs that are not simply involving the creation of a new product or a fast service.

Innovation, quality, promptness are just the basic requisite for a company that wants to survive in nowadays market.

70 years old Walmec wants to amaze who believes that the productive future is only tied to certain areas by continuing to offer a 100% MADE IN ITALY product.

Amaze who believes that manufacturing technologies are already established by investing and renewing its equipment with constantly more advanced CNC, automate and incredibly precise. Amaze who believes that you cannot go beyond some predetermined frameworks of products' constructive nature by exploring unused and charming roads, made of hyper technological and super performing materials.

To amaze is simply to think outside the box and to allow all the people that work with our products to find non just the quality, the price and the service that they righteously demand, but above all to try something completely unexpected, unthinkable, unpredictable.

Walmec is ready for it and we are sure that we together will amaze.



WALMEC S.P.A.
IS UNI EN ISO 9001:2008 CERTIFIED
WITH CERTIFICATE NR. 343/96/S

WWW.WALMEC.COM

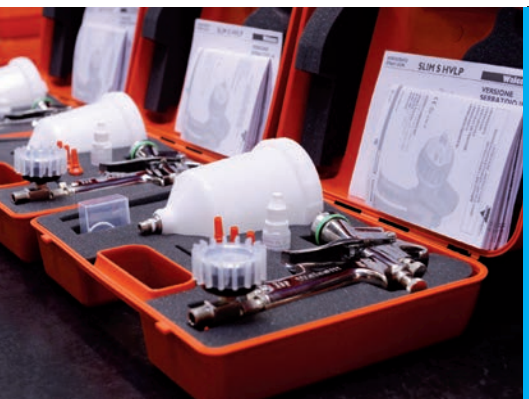

GENESI CARBONIO 360

We are not just talking about a high performance and low product consuming spray gun.

We are talking about a revolution in the painting scenario.

Over 2 years of studies and researches to accomplish the most ambitious project ever undertaken before to launch a new product. Real, deep, structural innovation, PAT PENDING.

Tradition and future merged for a fascinating and UNIQUE result.

For the first time in our industry, carbon fiber becomes a basic component to create a spray gun.

Together with aluminum, brass, stainless steel it gives life to the lightest and more maneuverable spray gun on the market, with 360 g of weigh, solvent and pickling resistant.

The high attention paid on details, down to the smallest component, makes this spray gun a thrilling professional tool for the user.

Tried and tested by the most important technical center of paint producers, GENESI CARBONIO 360 is about to become the key player in the body shop painting industry.



reddot award product design

GENESI CARBONIO 360 received the **Red Dot Product Design Award**, one of the most prestigious and important design prizes in the world.

The award wasn't only for the charming design but also for the significant innovation of this product, unique in its category. A further step in the quality path started by Walmec, in the product and engineering, we are proud and even more motivated toward an innovative and evolving future.

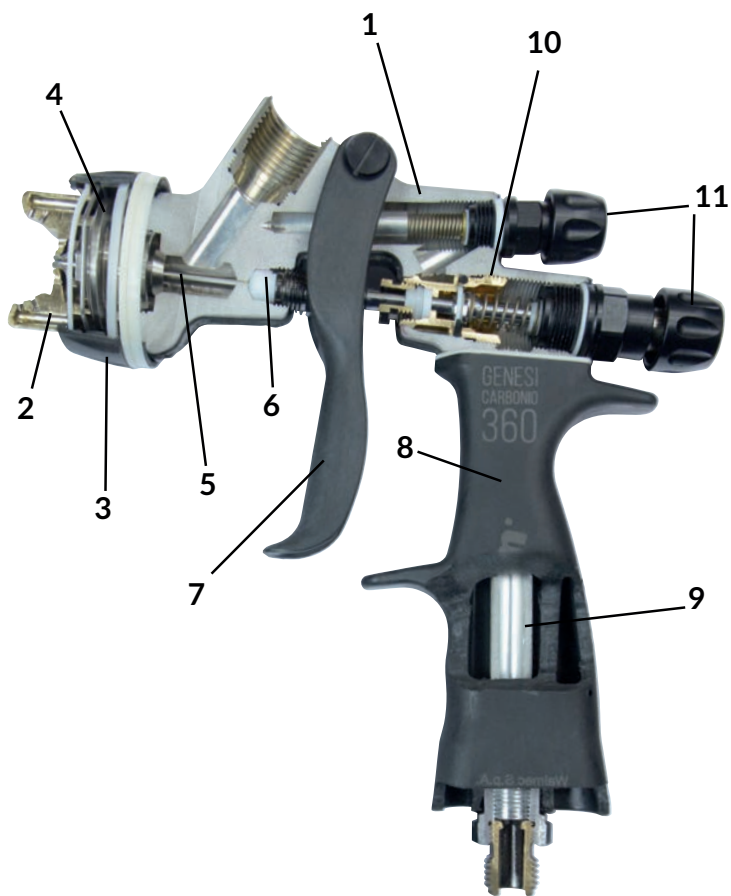

GENESI CARBONIO 360: product and specifications section

The spray gun is constructed with an air valve and needle on a single axis to provide higher performance and greater maintenance simplicity.

- 1 Forged aluminum and carbon fiber body
- 2 Nickel plated brass cap
- 3 Carbon fiber ring (cap)
- 4 Stainless steel AISI 303 nozzle - mechanical direct seal and air diffuser
- 5 Stainless steel AISI 303 needle
- 6 Needle packing nut
- 7 Ergonomic carbon fiber lever
- 8 Ergonomic carbon fiber handle
- 9 Aluminum air passage
- 10 Brass air valve and PTFE (teflon) seals, resistant to aggressive chemicals
- 11 Aluminum adjusting knobs, micro-precision adjustments for paint flow and fan

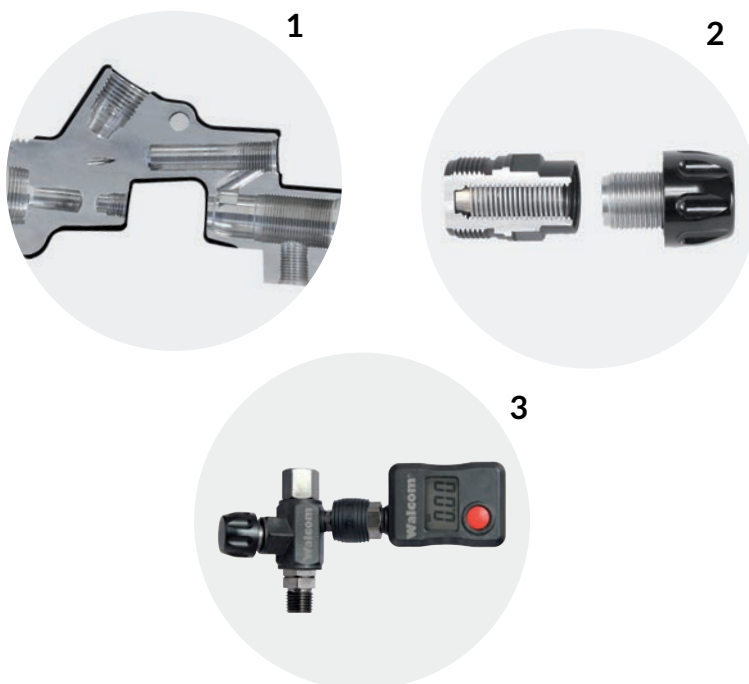

- 1 **BODY:**
Forged aluminum body and carbon fiber layer (1 mm).
CNC one by one with 5 axis advanced generation machine to deliver the highest reliability, quality and precision.
- 2 **ADJUSTMENT KNOBS:**
Anodized matt aluminum knob, stainless steel threaded pin, aluminum bush with stainless steel helicoid, low friction and maximum precision.
- 3 **AIR FLOW REGULATOR:**
Digital air flow regulator, semi-automatic quick disconnecting coupler, carbon fiber housing, battery can be easily replaced. Air inlet M 1/4 , straight compact or 30° swiveling version available.

Genesi Carbonio 360 HTE base

IDEAL FOR SOLVENT AND WATERBORNE BASE COAT.

HTE by Walcom®, more than 20 years of experience with the most popular technology in the market, the paint system that combines adequate atomizing pressure and high transferred efficiency, certified by international independent laboratory and research institutes.

The specific base air cap HP-High paint layout with proper distribution and flow orientation, 12 holes nozzle, precise and wide range of adjustment for fan and paint flow, are details that makes it a unique piece of equipment in the refinish application of the latest generation products.

GENESI CARBONIO HTE base is an excellent professional tool and these are some of the features:

- high atomization and product lay out,
- low air consumption (350 l/min),
- certified transfer efficiency over 70%,
- nozzle with special diffuser for air flow homogeneity,
- easy to adjust and versatility,
- ergonomic handle and lever,
- carbon fiber for lightness and corrosion resistance,
- 360 g weight, the lightest on the market.

Recommended nozzle Ø table,
see www.walmec.com

PAINTING DISTANCE

15-20 cm for an ideal material distribution.

BOX

Cardboard box package includes: sprayguns, rebuild kit (spring, seals, air valve) wrench tool, mineral lube oil, instruction manual and warranty.

SUITCASE

Rigid plastic suitcase includes: spraygun, air control with gauge (for item id 9730** and 9735**), rebuild kit (spring, seals, air valve), cup, wrench tool, mineral lube oil, instruction manual and warranty.



reddot award
product design



1 **NOZZLE**
Stainless steel nozzle with air diffuser TOPRING.

2 **FAN PATTERN CONTROL**
Completely open.

3 **MATERIAL FLOW CONTROL**
3-3.5 turn backward from close for waterborne, it may need to be adjusted based on temperature, humidity and painter speed. The material flow is very precise and can be adjusted up to 5 complete turns.

4 **AIR INLET PRESSURE**
For waterborne and solvent based materials 1.8 - 2.0 bar (specific setting for your paint can be found on our website).



TYPE

ITEM ID

RECOMMENDED USE

Genesi Carbonio 360 **HTE base**

Cup: POM C 680 cc
Cup aluminum 750 cc

Ref. 9730**
Ref. 9735**



BASE COAT

- Body: forged aluminum and carbon fiber
- Handle and trigger: carbon fiber
- Air cap HP: chemically nickeled plated brass
- Air cap ring: carbon fiber
- Nozzle: stainless steel AISI 303
- Needle - springs: stainless steel AISI 303
- Seals: PTFE (teflon) self and adjusting and manual regulation

• **Weight: 360 g**

- Operating air pressure: 2.0 bar
- Air consumption: 350 l/min
- Ø nozzle: 1.0 - 1.2 - 1.3 - 1.4 - 1.7 - 1.9

Digital pressure gauge and air control regulator with quick connection system, made of carbon fiber. 30° articulated fitting.

Note:
add nozzle Ø to Ref. (**)



Genesi Carbonio 360 **HTE base**

Cup: POM C 680 cc
Cup aluminum 750 cc

Ref. 9720**
Ref. 9725**



BASE COAT

- Body: forged aluminum and carbon fiber
- Handle and trigger: carbon fiber
- Air cap HP: chemically nickeled plated brass
- Air cap ring: carbon fiber
- Nozzle: stainless steel AISI 303
- Needle - springs: stainless steel AISI 303
- Seals: PTFE (teflon) self and adjusting and manual regulation

• **Weight: 360 g**

- Operating air pressure: 2.0 bar
- Air consumption: 350 l/min
- Ø nozzle: 1.0 - 1.2 - 1.3 - 1.4 - 1.7 - 1.9

Note:
add nozzle Ø to Ref. (**)



Genesi Carbonio 360 **HTE base**

Spraygun only

Ref. 9760**



BASE COAT

- Body: forged aluminum and carbon fiber
- Handle and trigger: carbon fiber
- Air cap HP: chemically nickeled plated brass
- Air cap ring: carbon fiber
- Nozzle: stainless steel AISI 303
- Needle - springs: stainless steel AISI 303
- Seals: PTFE (teflon) self and adjusting and manual regulation

• **Weight: 360 g**

- Operating air pressure: 2.0 bar
- Air consumption: 350 l/min
- Ø nozzle: 1.0 - 1.2 - 1.3 - 1.4 - 1.7 - 1.9

Note:
add nozzle Ø to Ref. (**)



Genesi Carbonio 360 HTE clear

IDEAL FOR CLEAR CLOAT APPLICATION MS-HS UHS ACRYLICS.

We developed a new specific version for improved transfer efficiency and more quality results, HTE clear with the HA-high atomization air cap that allows to achieve exceptional results, an amazing fan pattern and a perfect and even paint distribution with really low orange peel effect.

The wide and precise range on the paint control regulation allow each painter to find the best setting for his personal spraying style.

GENESI CARBONIO HTE is an excellent professional tool and these are some of the features:

- high atomization and product lay out,
- low air consumption (380 l/min),
- certified transfer efficiency over 70%,
- nozzle with special diffuser for air flow homogeneity,
- easy to adjust and versatility,
- ergonomic handle and trigger,
- carbon fiber for lightness and corrosion resistance,
- 360 g weight, the lightest on the market.

Recommended nozzle Ø table,
see www.walmec.com

PAINTING DISTANCE

15-20 cm for an ideal
material distribution.

BOX

Cardboard box package
includes: sprayguns, re-
build kit (spring, seals, air
valve) wrench tool, mi-
neral lube oil, instruction
manual and warranty.

SUITCASE

Rigid plastic suitcase in-
cludes: spraygun, air control
with gauge (for item id
9630** and 9635**), re-
build kit (spring, seals, air
valve), cup, wrench tool,
mineral lube oil, instruction
manual and warranty.



reddot award
product design



① **NOZZLE**
Stainless steel nozzle
with air diffuser
TOPRING.

② **FAN PATTERN
CONTROL**
Completely open.

③ **MATERIAL FLOW
CONTROL**
3.5 - 5 turns backward
from close for clear MS-
HS-UHS and acrylics, it
may need to be adjusted
based on temperature,
humidity and painter
speed. The material flow
is very precise and can be
adjusted up to 5 comple-
te turns.

④ **AIR INLET
PRESSURE**
2.0 bar from closed for
clear MS-HS-UHS and
acrylics (specific setting
for your paint can be
found on our website).



TYPE

ITEM ID

RECOMMENDED USE

Genesi Carbonio 360 HTE clear

Cup: POM C 680 cc

Ref. 9630**

Cup aluminum 750 cc

Ref. 9635**

- Body: forged aluminum and carbon fiber
- Handle and trigger: carbon fiber
- Air cap HA: chemically nickeled plated brass
- Air cap ring: carbon fiber
- Nozzle: stainless steel AISI 303
- Needle - springs: stainless steel AISI 303
- Seals: PTFE (teflon) self and adjusting and manual regulation

• **Weight: 360 g**

- Operating air pressure: 2.0 bar
- Air consumption: 380 l/min
- Ø nozzle: 1.1 - 1.2 - 1.3 - 1.4 - 1.7 - 1.9

Digital pressure gauge and air control regulator with quick connection system, made of carbon fiber. 30° articulated fitting.



BASE COAT
CLEAR COAT

Note:
add nozzle Ø to Ref. (**)



Genesi Carbonio 360 HTE clear

Cup: POM C 680 cc

Ref. 9620**

Cup aluminum 750 cc

Ref. 9625**

- Body: forged aluminum and carbon fiber
- Handle and trigger: carbon fiber
- Air cap HA: chemically nickeled plated brass
- Air cap ring: carbon fiber
- Nozzle: stainless steel AISI 303
- Needle - springs: stainless steel AISI 303
- Seals: PTFE (teflon) self and adjusting and manual regulation

• **Weight: 360 g**

- Operating air pressure: 2.0 bar
- Air consumption: 380 l/min
- Ø nozzle: 1.1 - 1.2 - 1.3 - 1.4 - 1.7 - 1.9



BASE COAT
CLEAR COAT

Note:
add nozzle Ø to Ref. (**)



Genesi Carbonio 360 HTE clear

Spraygun only

Ref. 9660**

- Body: forged aluminum and carbon fiber
- Handle and trigger: carbon fiber
- Air cap HA: chemically nickeled plated brass
- Air cap ring: carbon fiber
- Nozzle: stainless steel AISI 303
- Needle - springs: stainless steel AISI 303
- Seals: PTFE (teflon) self and adjusting and manual regulation

• **Weight: 360 g**

- Operating air pressure: 2.0 bar
- Air consumption: 380 l/min
- Ø nozzle: 1.1 - 1.2 - 1.3 - 1.4 - 1.7 - 1.9



BASE COAT
CLEAR COAT

Note:
add nozzle Ø to Ref. (**)



Genesi Carbonio 360 HVLP

IDEAL FOR SOLVENT AND WATERBORNE BASE COATS.

It's a perfect tool for waterborne base coats application and solvent based, color match master, air cap pressure 0.7 bar for a traditional HVLP as from California norm n. 1551 SCAQMD and more then 65% efficiency transfer rate. It's very low in air consumption, 360 l/min, equal to LV (low volume) technology consequently saving air and energy. GENESI CARBONIO 360 HVLP is an excellent professional tool and these are some of the features:

- high atomization and product lay out for base coats,
- excellent color match, certified,
- low air consumption (360 l/min),
- certified transfer efficiency over 70%,
- nozzle with special diffuser for airflow homogeneity,
- easy to adjust and versatility,
- ergonomic handle and trigger,
- resistant to solvent and pickling chemicals,
- carbon fiber for lightness and corrosion resistance,
- 360 g weight, the lightest on the market.

Recommended nozzle Ø table,
see www.walmec.com

PAINTING DISTANCE

10-15 cm for an ideal material distribution.

BOX

Cardboard box package includes: sprayguns, rebuild kit (spring, seals, air valve) wrench tool, mineral lube oil, instruction manual and warranty.

SUITCASE

Rigid plastic suitcase includes: spraygun, air control with gauge (for item id 9830** and 9835**), rebuild kit (spring, seals, air valve), cup, wrench tool, mineral lube oil, instruction manual and warranty.



reddot award
product design



1 **NOZZLE**
Stainless steel nozzle with air diffuser TOPRING.

2 **FAN PATTERN CONTROL**
Completely open.

3 **MATERIAL FLOW CONTROL**
3-3.5 turn backward from close for waterborne, it may need to be adjusted based on temperature, humidity and painter speed. The material flow is very precise and can be adjusted up to 5 complete turns.

4 **AIR INLET PRESSURE**
For waterborne and solvent based materials 1.8 - 2.0 bar (specific setting for your paint can be found on our website).



TYPE

ITEM ID

RECOMMENDED USE

Genesi Carbonio 360 **HVLP**

Cup: POM C 680 cc
Cup aluminum 750 cc

Ref. 9830**
Ref. 9835**



BASE COAT

- Body: forged aluminum and carbon fiber
- Handle and trigger: carbon fiber
- Air cap : chemically nickeled plated brass
- Air cap ring: carbon fiber
- Nozzle: stainless steel AISI 303
- Needle - springs: stainless steel AISI 303
- Seals: PTFE (teflon) self and adjusting and manual regulation

Weight: 360 g

- Operating air pressure: 2.0 bar
- Air consumption: 360 l/min
- Ø nozzle: 1.0 - 1.2 - 1.3 - 1.4 - 1.5 - 1.7 - 1.9

Digital pressure gauge and air control regulator with quick connection system, made of carbon fiber. 30° articulated fitting.

Note:
add nozzle Ø to Ref. (**)



Genesi Carbonio 360 **HVLP**

Cup: POM C 680 cc
Cup aluminum 750 cc

Ref. 9820**
Ref. 9825**



BASE COAT

- Body: forged aluminum and carbon fiber
- Handle and trigger: carbon fiber
- Air cap: chemically nickeled plated brass
- Air cap ring: carbon fiber
- Nozzle: stainless steel AISI 303
- Needle - springs: stainless steel AISI 303
- Seals: PTFE (teflon) self and adjusting and manual regulation

Weight: 360 g

- Operating air pressure: 2.0 bar
- Air consumption: 360 l/min
- Ø nozzle: 1.0 - 1.2 - 1.3 - 1.4 - 1.5 - 1.7 - 1.9

Note:
add nozzle Ø to Ref. (**)



Genesi Carbonio 360 **HVLP**

Spraygun only

Ref. 9860**



BASE COAT

- Body: forged aluminum and carbon fiber
- Handle and trigger: carbon fiber
- Air cap: chemically nickeled plated brass
- Air cap ring: carbon fiber
- Nozzle: stainless steel AISI 303
- Needle - springs: stainless steel AISI 303
- Seals: PTFE (teflon) self and adjusting and manual regulation

Weight: 360 g

- Operating air pressure: 2.0 bar
- Air consumption: 360 l/min
- Ø nozzle: 1.0 - 1.2 - 1.3 - 1.4 - 1.5 - 1.7 - 1.9

Note:
add nozzle Ø to Ref. (**)



Genesi Carbonio 360 GEO

IDEAL FOR WATERBORNE BASE AND SOLVENT.

One of the masterpiece of the Walcom® brand, the GEO dual atomization system, hvp in respect to the California norm n. 1151 SCAQMD with 0.7 bar at the air cap and more then 65% transfer efficiency, perfect for color match. The dual atomizing nozzle, 6 pre-atomizing holes, excellent product lay out, unique system that delivers incredible performance.

It's very low in air consumption 425 l/min, saving air and consequently energy.

GENESI CARBONIO GEO is an excellent professional tool and these are some of the features:

- high atomization and product lay out for base coats,
- excellent color match, certified,
- low air consumption (425 l/min) LV technology,
- certified transfer efficiency over 70%,
- nozzle with special diffuser for airflow homogeneity,
- easy to adjust and versatility,
- ergonomic handle and trigger,
- resistant to solvent and pickling chemicals,
- carbon fiber for lightness and corrosion resistance,
- 360 g weight, the lightest on the market.

Recommended nozzle Ø table,
see www.walmec.com

PAINTING DISTANCE

10-15 cm for an ideal material distribution.

BOX

Cardboard box package includes: sprayguns, rebuild kit (spring, seals, air valve) wrench tool, mineral lube oil, instruction manual and warranty.

SUITCASE

Rigid plastic suitcase includes: spraygun, air control with gauge (for item id 9930** and 9935**), rebuild kit (spring, seals, air valve), cup, wrench tool, mineral lube oil, instruction manual and warranty.



reddot award
product design



- 1 GEO NOZZLE**
Double atomization patented nozzle that provides high performance levels even when working in low pressure (0.7 bar) with UHS transparent.
- 2 FAN PATTERN CONTROL**
Completely open.
- 3 MATERIAL FLOW CONTROL**
3-3.5 turn backward from close for waterborne, it may need to be adjusted based on temperature, humidity and painter speed. The material flow is very precise and can be adjusted up to 5 complete turns.
- 4 AIR INLET PRESSURE**
For waterborne and solvent based materials 1.8 - 2.0 bar (specific setting for your paint can be found on our website).



TYPE

ITEM ID

RECOMMENDED USE

Genesi Carbonio 360 GEO

Cup: POM C 680 cc

Ref. 9930**

Cup aluminum 750 cc

Ref. 9935**

- Body: forged aluminum and carbon fiber
- Handle and trigger: carbon fiber
- Air cap: chemically nickeled plated brass
- Air cap ring: carbon fiber
- GEO nozzle: stainless stell AISI 303
- Needle - springs: stainless stell AISI 303
- Seals: PTFE (teflon) self and adjsuting and manual regulation

• **Weight: 360 g**

- Operating air pressure: 2.0 bar
- Air consumption: 425 l/min
- Ø nozzle: 1.0 - 1.2 - 1.3 - 1.4 - 1.5 - 1.7 - 1.9

Digital pressure gauge and air control regulator with quick connection sytem, made of carbon fiber. 30° articulated fitting.



BASE COAT

Note:
add nozzle Ø to Ref. (**)



reddot award
product design



Genesi Carbonio 360 GEO

Cup: POM C 680 cc

Ref. 9920**

Cup aluminum 750 cc

Ref. 9925**

- Body: forged aluminum and carbon fiber
- Handle and trigger: carbon fiber
- Air cap: chemically nickeled plated brass
- Air cap ring: carbon fiber
- GEO nozzle: stainless stell AISI 303
- Needle - springs: stainless stell AISI 303
- Seals: PTFE (teflon) self and adjsuting and manual regulation

• **Weight: 360 g**

- Operating air pressure: 2.0 bar
- Air consumption: 425 l/min
- Ø nozzle: 1.0 - 1.2 - 1.3 - 1.4 - 1.5 - 1.7 - 1.9



BASE COAT

Note:
add nozzle Ø to Ref. (**)



reddot award
product design



Genesi Carbonio 360 GEO

Spraygun only

Ref. 9960**

- Body: forged aluminum and carbon fiber
- Handle and trigger: carbon fiber
- Air cap: chemically nickeled plated brass
- Air cap ring: carbon fiber
- GEO nozzle: stainless stell AISI 303
- Needle - springs: stainless stell AISI 303
- Seals: PTFE (teflon) self and adjsuting and manual regulation

• **Weight: 360 g**

- Operating air pressure: 2.0 bar
- Air consumption: 425 l/min
- Ø nozzle: 1.0 - 1.2 - 1.3 - 1.4 - 1.5 - 1.7 - 1.9



BASE COAT

Note:
add nozzle Ø to Ref. (**)



reddot award
product design



GENESI Top Line

In 2006, Walcom® presented the GENESI first version, a finishing spray gun that offered the automotive industry a new, more reliable, more efficient, more qualitative and ecological way of working.

Quite a few years have passed since that time and these great characteristics of GENESI, allowed Walcom® not only to establish itself in the professional painting international industry but also gave the spark to new projects linked to high quality spray guns.

The last version called Top Line remains a point of reference in the painting scenario, for its versatility, reliability and quality that mark its performances. Made with top quality raw materials, respecting the manufacturing tradition of aluminum, brass, stainless steel, GENESI Top Line is a spray gun that keeps on having many evaluators, who make it a strong and deeply present name in this industry, which is constantly looking for something innovative.

GENESI Top Line, thanks to its accurate polishing and chromed finishing, combines a refined esthetic and a high resistance to the aggression of solvents and pickling, other than allowing a fast and easy cleaning.

A product with great quality and substance, approved by the technical centers of painting manufacturers and professional painters.



GENESI Top Line: product and specifications section

The spray gun is constructed with an air valve and needle on a single axis to provide higher performance and greater maintenance simplicity.

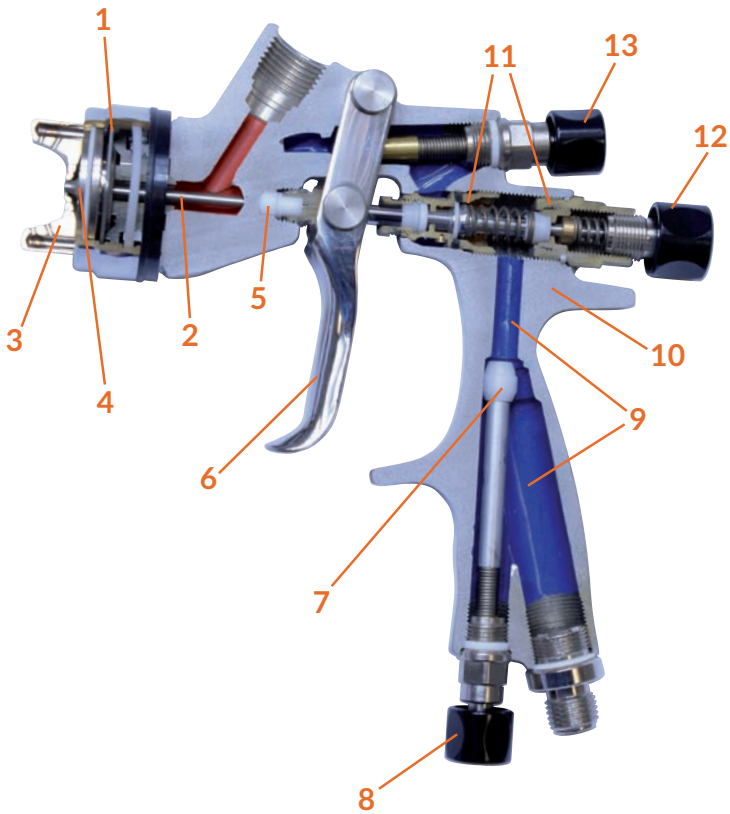

- 1 Chrome plated brass nut.
- 2 Stainless steel needle.
- 3 Chemical nickel plated brass cap.
- 4 Stainless steel nozzle with mechanical seal.
- 5 Adjustable needle stuffing box.
- 6 Polished stainless steel ergonomic lever.
- 7 Air flow regulator with acetyl shutter for perfect adjustment. Resistant to all solvents.
- 8 Knob for air flow adjustments.
- 9 Calibrated air passages.
- 10 Polished and chrome-plated forged aluminium body for total protection.
- 11 Brass valve for maximum reliability and PTFE (Teflon) gaskets resistant to all water and solvent based paints.
- 12 Product opening adjustment knob with reference tags.
- 13 Fan adjustment knob with reference numbers.



- 1 **BODY:**
Polished chrome-plated forged aluminium, resistant to the most aggressive solvents. Air passage calibration is guaranteed by numeric controlled machine processing.
- 2 **NOZZLE:**
New 12 distribution hole stainless steel nozzle in three versions GEO, HTE and HVLP, to guarantee constant air flow volume to, the cap; easy to remove for cleaning and controls, thanks to the supplied Allen key.
- 3 **"Top" AIR CAP:**
Chemical nickel-plated brass, ideal for water-based, solvent and VHS transparent paints. Renewed hole design, inclinations and dynamic flows guarantee the top level of performance and reliability.
- 4 **NEEDLE:**
CNC processed stainless steel for maximum durability and guaranteed precision in nozzle alignment.

Genesi Top Line HTE-HVLP-GEO

Genesi Top Line is available in three versions: **HTE**, **HVLP** and **GEO**.

HTE is the high transfer efficiency solution, ideal for waterborne and solvent base coats application as well as MS, HS and UHS.

Setting the spraygun between 2 bar and 2.5 bar allows to handle both base and clear coats.

The 1.2 - 1.4 bar air cap pressure guarantees an excellent atomizing result. Low air consumption, high transfer efficiency (> 65%), easy maintenance and corrosion and chemical resistance are qualities that makes this spraygun reliable, practical and performing.

HVLP is the ideal solution for waterborne and solvent based coats..

The HVLP system, 0.7 bar air cap pressure guarantees color matches and over 65% transfer efficiency.

This model works at 2 bar air pressure inlet.

It's a reliable and practical tool, easy to maintain, resistant to corrosion and chemical liquids.

GEO available also for the top line is series is our double atomizing system, a step ahead any HVLP spraygun in the market thanks to the patented nozzle with the pre atomization 6 holes.

It's HVLP and works at 0.7 bar air cap pressure with a 2 bar inlet pressure.

Low air consumption, for a solid and resistant spraygun.

Recommended nozzle Ø table,
see www.walmec.com

PAINTING DISTANCE

Between 10 and 15 cm for GEO and HVLP, between 15 and 20 cm for HTE, guarantees improved product layout on painted parts.

SUITCASE

All spray guns of the Walcom® range are supplied in easy to use rigid plastic cases containing all the accessories for a proper cleaning and maintenance of the product.



- 1 GEO NOZZLE**
Double atomization patented nozzle that provides high performance levels even when working in low pressure (0.7 bar) with UHS transparent.
- 2 AIR ADJUSTMENT**
Completely open for total air flow.
- 3 AIR INLET PRESSURE**
2 bar for opaque base (H₂O and solvent); transparent and pastel MS-HS-UHS.
- 4 FAN PATTERN CONTROL**
Completely open for ideal paint atomization.
- 5 MATERIAL FLOW CONTROL**
From 3 to 3.5 turns. Subjective value and therefore modifiable according to the user's habits.

TYPE

ITEM ID

RECOMMENDED USE

Genesi S HTE

Cup: POM C 680 cc
Cup: aluminium 750 cc

Ref. 9530**
Ref. 9535**

- Body: forged and chrome-plated aluminium
- Top air cap: chemical nickel-plated brass
- Nozzle: AISI 303 stainless steel
- Needle-spring: stainless steel
- Seal: self-lubricating and adjustable PTFE (Teflon)
- Weight: 565 g
- Operating air pressure: 2.0 - 2.5 bar
- Air consumption: 300 - 340 l/min
- Ø nozzle: 1.0 - 1.2 - 1.3 - 1.4 - 1.7 - 1.9

Top air inlet pressure regulator with pressure gauge



BASE COAT
CLEAR COAT

Note:
add nozzle Ø to Ref. (**)



Genesi I HTE

Camlock suction cup: aluminium 1000 cc

Ref. 9540**

- Body: forged and chrome-plated aluminium
- Top air cap: chemical nickel-plated brass
- Nozzle: AISI 303 stainless steel
- Needle-spring: stainless steel
- Seal gaskets: self-lubricating and adjustable PTFE (Teflon)
- Weight: 605 g
- Operating air pressure: 2.0 - 2.5 bar
- Air consumption: 300 - 340 l/min.
- Ø nozzle: 1.0 - 1.2 - 1.3 - 1.4 - 1.7 - 1.9

Top air inlet pressure regulator with pressure gauge



BASE COAT
CLEAR COAT

Note:
add nozzle Ø to Ref. (**)



Genesi SP HTE

To be used through pressurized containers, low pressure pumps
Product inlet M1/4"

Ref. 9550**

- Body: forged and chrome-plated aluminium
- Top air cap: chemical nickel-plated brass
- Nozzle: AISI 303 stainless steel
- Needle-spring: stainless steel
- Seal gaskets: self-lubricating and adjustable PTFE (Teflon)
- Weight: 605 g
- Operating air pressure: 2.0 - 2.5 bar
- Air consumption: 300 - 340 l/min.
- Ø nozzle: 1.0 - 1.2 - 1.3 - 1.4 - 1.7 - 1.9

Top air inlet pressure regulator with pressure gauge



BASE COAT
CLEAR COAT

Note:
add nozzle Ø to Ref. (**)



TYPE

ITEM ID

RECOMMENDED USE

Genesi S HVLP

Cup: POM C 680 cc
Cup: aluminium 750 cc

Ref. 9430**
Ref. 9435**

- Body: forged and chrome-plated aluminium
- Top air cap: chemical nickel-plated brass
- Nozzle: AISI 303 stainless steel
- Needle-spring: stainless steel
- Seal gaskets: self-lubricating and adjustable PTFE (Teflon)
- Weight: 565 g
- Operating air pressure: 2.0 - 2.5 bar
- Air consumption: 310 - 350 l/min
- Ø nozzle: 1.0 - 1.2 - 1.3 - 1.4 - 1.7 - 1.9

Top air inlet pressure regulator with pressure gauge



BASE COAT

Note:
add nozzle Ø to Ref. (**)



Genesi I HVLP

Camlock suction cup: aluminium 1000 cc

Ref. 9440**

- Body: forged and chrome-plated aluminium
- Top air cap: chemical nickel-plated brass
- Nozzle: AISI 303 stainless steel
- Needle-spring: stainless steel
- Seal gaskets: self-lubricating and adjustable PTFE (Teflon)
- Weight: 605 g
- Operating air pressure: 2.0 - 2.5 bar
- Air consumption: 310 - 350 l/min.
- Ø nozzle: 1.0 - 1.2 - 1.3 - 1.4 - 1.7 - 1.9

Top air inlet pressure regulator with pressure gauge



BASE COAT

Note:
add nozzle Ø to Ref. (**)



Genesi SP HVLP

To be used through pressurized containers, low pressure pumps
Product inlet M1/4"

Ref. 9450**

- Body: forged and chrome-plated aluminium
- Top air cap: chemical nickel-plated brass
- Nozzle: AISI 303 stainless steel
- Needle-spring: stainless steel
- Seal gaskets: self-lubricating and adjustable PTFE (Teflon)
- Weight: 605 g
- Operating air pressure: 2.0 - 2.5 bar
- Air consumption: 310 - 350 l/min.
- Ø nozzle: 1.0 - 1.2 - 1.3 - 1.4 - 1.7 - 1.9

Top air inlet pressure regulator with pressure gauge



BASE COAT

Note:
add nozzle Ø to Ref. (**)



TYPE

ITEM ID

RECOMMENDED USE

Genesi S GEO

Cup: POM C 680 cc
Cup: aluminium 750 cc

Ref. 9330**
Ref. 9335**

- Body: forged and chrome-plated aluminium
- Top air cap: chemical nickel-plated brass
- GEO Nozzle: AISI 303 stainless steel
- Needle-spring: stainless steel
- Seal gaskets: self-lubricating and adjustable PTFE (Teflon)
- Weight: 560 g
- Operating air pressure: 2.0 - 2.5 bar
- Air consumption: 320 - 360 l/min.
- Ø nozzle: 1.0 - 1.3 - 1.5 - 1.7 - 1.9

Top air inlet pressure regulator with pressure gauge



BASE COAT

Note:
add nozzle Ø to Ref. (**)



Genesi I GEO

Camlock suction cup: aluminium 1000 cc

Ref. 9340**

- Body: forged and chrome-plated aluminium
- Top air cap: chemical nickel-plated brass
- GEO Nozzle: AISI 303 stainless steel
- Needle-spring: stainless steel
- Seal gaskets: self-lubricating and adjustable PTFE (Teflon)
- Weight: 600 g
- Operating air pressure: 2.0 - 2.5 bar
- Air consumption: 320 - 360 l/min.
- Ø nozzle: 1.0 - 1.3 - 1.5 - 1.7 - 1.9

TOP air inlet pressure regulator with pressure gauge



BASE COAT

Note:
add nozzle Ø to Ref. (**)



Genesi SP GEO

To be used through pressurized containers, low pressure pumps
Product inlet M1/4"

Ref. 9350**

- Body: forged and chrome-plated aluminium
- Top air cap: chemical nickel-plated brass
- GEO Nozzle: AISI 303 stainless steel
- Needle-spring: stainless steel
- Seal gaskets: self-lubricating and adjustable PTFE (Teflon)
- Weight: 600 g
- Operating air pressure: 2.0 - 2.5 bar
- Air consumption: 320 - 360 l/min.
- Ø nozzle: 1.0 - 1.3 - 1.5 - 1.7 - 1.9

Top air inlet pressure regulator with pressure gauge



BASE COAT

Note:
add nozzle Ø to Ref. (**)



Slim HTE-HTE SR-HVLP system

FOR PRIMER BODY SHOP APPLICATION AND INDUSTRIAL SECTOR.

Spray guns mainly designed for bodywork base application but which, thanks to the ability to adapt to different paint product viscosities, can also be used in the industrial and woodwork sectors.

High Slim 1.3 and 1.5 atomization level, especially in the HTE version, makes it an excellent finish spray gun for the bodywork sector.

Appreciated for its light weight, ergonomics, flexibility and quality details, Slim now plays a leading role in the high level paint market.

Among the distinguishing Slim features are:

- reduced air consumption (about 230 l/min in the HVLP version, max 260 l/min in HTE);
- high pulverising air cap (in the HTE version);
- transfer efficiency over 80% tested by the most qualified Italian and European boards;
- ecology regulation nr. 1151 SCAQMD compliant in the HVLP version (cap pressure 0.7 bar transfer efficiency > 65%);
- maintenance ease;
- resistant to aggressive solvents and strippers.

Recommended nozzle Ø table,
see www.walmec.com

PAINTING DISTANCE

Between 10 and 15 cm for the HVLP version.

Between 15 and 20 cm for the HTE version, guarantees improved product layout on painted parts.

SUITCASE

All spray guns of the Walcom® range are supplied in easy to use rigid plastic cases containing all the accessories for a proper cleaning and maintenance of the product.



- 1 AIR ADJUSTMENT**
Completely open for total air flow.
- 2 AIR INLET PRESSURE**
2 bar for HVLP and HTE version.
- 3 FAN PATTERN CONTROL**
Completely open for ideal paint atomization.
- 4 MATERIAL FLOW CONTROL**
From 3.5 to 4.5 turns. Subjective value and therefore modifiable according to the user's habits.

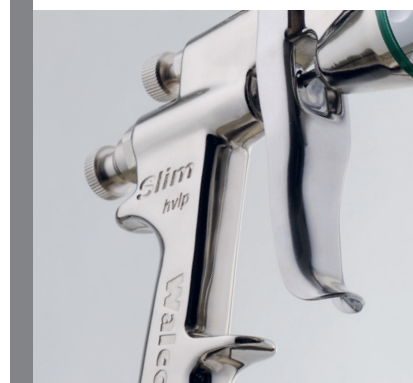

SLIM: product and specifications section

The spray gun is constructed with air valve and needle on a single axis to provide higher performance and greater.

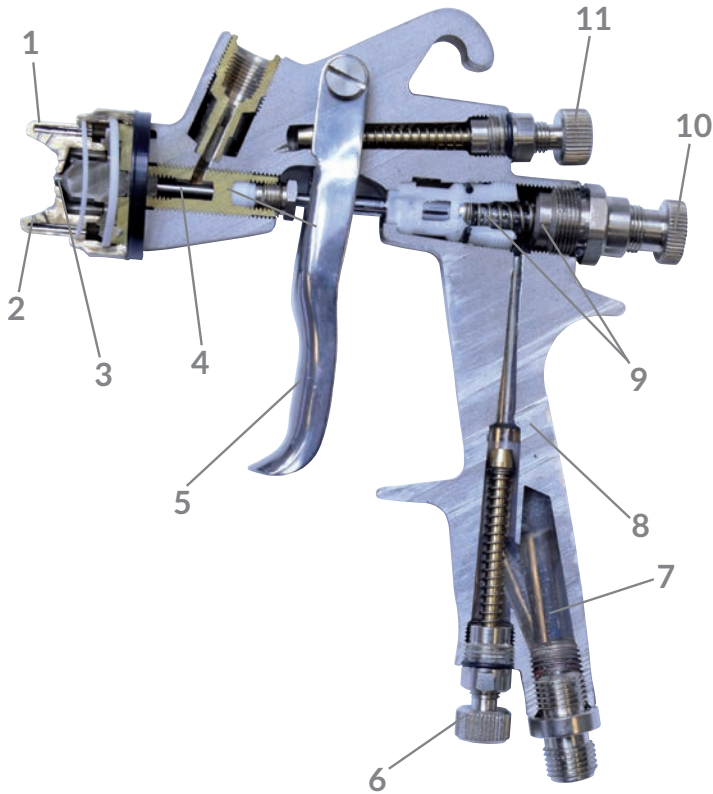

- 1 Chrome plated brass nut.
- 2 Chemical nickel-plated brass cap.
- 3 Stainless steel nozzle.
- 4 Stainless steel needle.
- 5 Polished stainless steel ergonomic lever.
- 6 Air flow regulation knob.
- 7 Calibrated air passages.
- 8 Polished and chrome-plated aluminium body for total protection.
- 9 PTFE (Teflon) gaskets and valve, resistant to all water and solvent based paints with automatic adjustment system.
- 10 Product opening knob.
- 11 Fan adjustment knob.

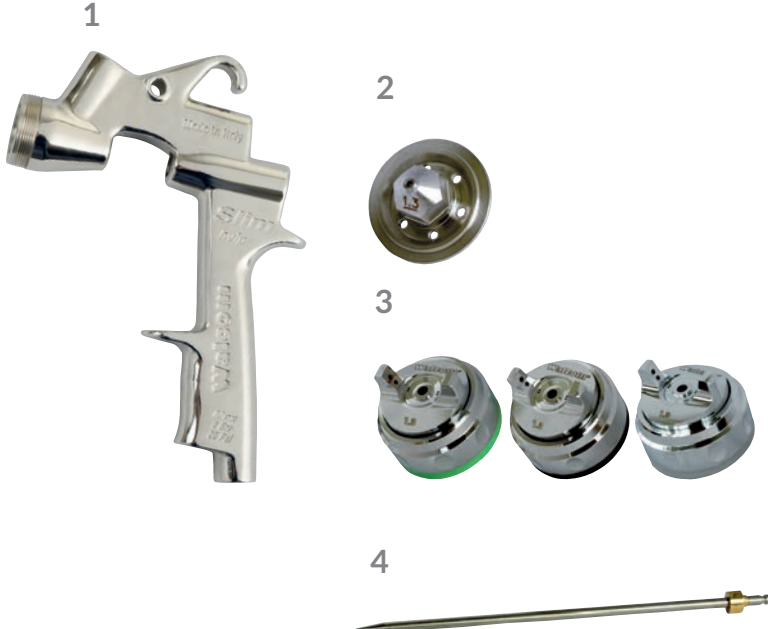

- 1 **BODY:**
Chemical nickel plated and polished aluminium. Finishing treatments make it resistant to solvents. The particular slim shape makes the spray gun ergonomic and easy to use.
- 2 **NOZZLE:**
Monobloc stainless steel unit. The holes for diffusion provide a constant and high volume air flow to the cap.
- 3 **AIR CAP:**
Chemical nickel-plated brass guarantees precision and maximum durability. The processing precision of this material provides constant and high level atomization levels.
- 4 **NEEDLE:**
CNC processed stainless steel for maximum durability and guaranteed precision in nozzle alignment.

TYPE

ITEM ID

RECOMMENDED USE

Slim S HTE

Cup: POM C 680 cc
Cup: aluminium 750 cc

Ref. 10068**
Ref. 10069**

- Body: chemical nickel-plated polished aluminium
- Air cap: chemical nickel-plated brass
- Nozzle: AISI 303 stainless steel
- Needle-spring: stainless steel
- Seal gaskets: self-lubricating and adjustable PTFE (Teflon)
- Weight: 535 g
- Operating air pressure: 2.0 - 2.5 bar
- Air consumption: 220 - 260 l/min
- Ø nozzle: 1.0 - 1.2 - 1.3 - 1.5 - 1.7 - 1.9 - 2.2 - 2.5

Air inlet pressure regulator with pressure gauge



BASE COAT
CLEAR COAT
PRIMER

Note:
add nozzle Ø to Ref. (**)



Slim I HTE

Bayonet suction cup: aluminium 1000 cc

Ref. 10077**

- Body: chemical nickel-plated polished aluminium
- Air cap: chemical nickel-plated brass
- Nozzle: AISI 303 stainless steel
- Needle-spring: stainless steel
- Seal gaskets: self-lubricating and adjustable PTFE (Teflon)
- Weight: 544 g
- Operating air pressure: 2.0 - 2.5 bar
- Air consumption: 220 - 260 l/min
- Ø nozzle: 1.0 - 1.2 - 1.3 - 1.5 - 1.7 - 1.9 - 2.2 - 2.5

Air inlet pressure regulator with pressure gauge



BASE COAT
CLEAR COAT
PRIMER

Note:
add nozzle Ø to Ref. (**)



Slim SP HTE

To be used through pressurized containers, low pressure pumps
Product inlet M1/4". Adaptor F 1/4" M 3/8" included.

Ref. 10078**

- Body: chemical nickel-plated polished aluminium
- Air cap: chemical nickel-plated brass
- Nozzle: AISI 303 stainless steel
- Needle-spring: stainless steel
- Seal gaskets: self-lubricating and adjustable PTFE (Teflon)
- Weight: 544 g
- Operating air pressure: 2.0 - 2.5 bar
- Air consumption: 220 - 260 l/min
- Ø nozzle: 1.0 - 1.2 - 1.3 - 1.5 - 1.7 - 1.9 - 2.2

Air inlet pressure regulator with pressure gauge



BASE COAT
CLEAR COAT
PRIMER

Note:
add nozzle Ø to Ref. (**)



TYPE

ITEM ID

RECOMMENDED USE

Slim S HTE SR

Cup: POM C 680 cc

Ref. 10083**

Cup: aluminium 750 cc

Ref. 10084**

- Body: chemical nickel-plated polished aluminium
- Air cap: chemical nickel-plated brass
- Nozzle: AISI 303 stainless steel
- Needle-spring: stainless steel
- Seal gaskets: self-lubricating and adjustable PTFE (Teflon)
- Weight: 535 g
- Operating air pressure: 2.0 - 2.5 bar
- Air consumption: 220 - 260 l/min
- Ø nozzle: 1.0 - 1.2 - 1.3 - 1.5 - 1.7 - 1.9 - 2.2 - 2.5



BASE COAT
CLEAR COAT
PRIMER

Note:
add nozzle Ø to Ref. (**)



Slim I HTE SR

Bayonet suction cup: aluminium 1000 cc

Ref. 10088**

- Body: chemical nickel-plated polished aluminium
- Air cap: chemical nickel-plated brass
- Nozzle: AISI 303 stainless steel
- Needle-spring: stainless steel
- Seal gaskets: self-lubricating and adjustable PTFE (Teflon)
- Weight: 544 g
- Operating air pressure: 2.0 - 2.5 bar
- Air consumption: 220 - 260 l/min
- Ø nozzle: 1.0 - 1.2 - 1.3 - 1.5 - 1.7 - 1.9 - 2.2 - 2.5



BASE COAT
CLEAR COAT
PRIMER

Note:
add nozzle Ø to Ref. (**)



Slim SP HTE SR

To be used through pressurized containers, low pressure pumps
Product inlet M1/4". Adaptor F 1/4" M 3/8" included.

Ref. 10089**

- Body: chemical nickel-plated polished aluminium
- Air cap: chemical nickel-plated brass
- Nozzle: AISI 303 stainless steel
- Needle-spring: stainless steel
- Seal gaskets: self-lubricating and adjustable PTFE (Teflon)
- Weight: 544 g
- Operating air pressure: 2.0 - 2.5 bar
- Air consumption: 220 - 260 l/min
- Ø nozzle: 1.0 - 1.2 - 1.3 - 1.5 - 1.7 - 1.9 - 2.2



BASE COAT
CLEAR COAT
PRIMER

Note:
add nozzle Ø to Ref. (**)



TYPE

ITEM ID

RECOMMENDED USE

Slim S HVLP

Cup: POM C 680 cc
Cup: aluminium 750 cc

Ref. 10060**
Ref. 10061**

- Body: chemical nickel-plated polished aluminium
- Air cap: chemical nickel-plated brass
- Nozzle: AISI 303 stainless steel
- Needle-spring: stainless steel
- Seal gaskets: self-lubricating and adjustable PTFE (Teflon)
- Weight: 535 g
- Operating air pressure: 2.0 bar
- Air consumption: 230 l/min
- Ø nozzle: 1.3 - 1.5 - 1.7 - 1.9 - 2.2

Air inlet pressure regulator with pressure gauge



PRIMER

Note:
add nozzle Ø to Ref. (**)



Slim I HVLP

Bayonet suction cup: aluminium 1000 cc

Ref. 10070**

- Body: chemical nickel-plated polished aluminium
- Air cap: chemical nickel-plated brass
- Nozzle: AISI 303 stainless steel
- Needle-spring: stainless steel
- Seal gaskets: self-lubricating and adjustable PTFE (Teflon)
- Weight: 544 g
- Operating air pressure: 2.0 bar
- Air consumption: 230 l/min
- Ø nozzle: 1.7 - 1.9 - 2.2

Air inlet pressure regulator with pressure gauge



PRIMER

Note:
add nozzle Ø to Ref. (**)



Slim SP HVLP

To be used through pressurized containers, low pressure pumps
Product inlet M1/4". Adaptor F 1/4" M 3/8" included.

Ref. 10071**

- Body: chemical nickel-plated polished aluminium
- Air cap: chemical nickel-plated brass
- Nozzle: AISI 303 stainless steel
- Needle-spring: stainless steel
- Seal gaskets: self-lubricating and adjustable PTFE (Teflon)
- Weight: 544 g
- Operating air pressure: 2.0 bar
- Air consumption: 230 l/min.
- Ø nozzle: 1.0 - 1.3 - 1.5 - 1.7 - 1.9 - 2.2

Air inlet pressure regulator with pressure gauge



PRIMER

Note:
add nozzle Ø to Ref. (**)



TYPE

ITEM ID

RECOMMENDED USE

Slim HVLP HD

Pressurised gravity cup POM C 680 cc

Ref. 10079**



- Pressurised gravity cup (M 1/4" product inlet): for high density products such as latex, polyurethane, gel coat, tixotropic products in the wood and industrial sectors
- Body: chemical nickel-plated polished aluminium
- Air cap: chemical nickel-plated brass
- Nozzle: AISI 303 stainless steel
- Needle-spring: stainless steel
- Seal gaskets: self-lubricating and adjustable PTFE (Teflon)
- Weight: 535 g
- Operating air pressure: 2.0 - 2.5 bar
- Air consumption 200 - 240 l/min
- Ø nozzle: 1.3 - 1.5 - 1.7 - 1.9 - 2.2

Double spray gun air inlet pressure regulator and pressurised cup with pressure gauge

Note:
add nozzle Ø to Ref. (**)



Slim HTE HD

Pressurised gravity cup POM C 680 cc

Ref. 10080**



- Pressurised gravity cup (M 1/4" product inlet): for high density products such as latex, polyurethane, gel coat, tixotropic products in the wood and industrial sectors
- Body: chemical nickel-plated polished aluminium
- Air cap: chemical nickel-plated brass
- Nozzle: AISI 303 stainless steel
- Needle-spring: stainless steel
- Seal gaskets: self-lubricating and adjustable PTFE (Teflon)
- Weight: 535 g
- Operating air pressure: 2.0 - 2.5 bar
- Air consumption 240 - 280 l/min
- Ø nozzle: 1.3 - 1.5 - 1.7 - 1.9 - 2.2

Double spray gun air inlet pressure regulator and pressurised cup with pressure gauge

Note:
add nozzle Ø to Ref. (**)



— EGO HTE-HVLP & GRAFO system —

FOR SPOT REPAIR AND PROFESSIONAL DECOR.

EGO HVLP developed from the GENESI experience, same concept, nature, materials, processing precision, level of atomization and design.

EGO HVLP is a small finishing spray gun, ideal for bodywork touch-ups but also for base and clear coats.

EGO HTE the cutting edge technology for a mini gun, unbelievable performance in the higher transfer efficiency version, ideal solution for base coats and clear coats, HS and UHS.

The reduced air consumption (less than 180 l/min), high transfer efficiency (over 80%) as well as the high atomizing cap and quality of each single component make this spray gun a bodywork treasure, combining practicality and manageability with quality and high class finish.

Recommended nozzle Ø table,
see www.walmec.com

PAINTING DISTANCE

Between 10 and 15 cm for the HVLP version.

Between 15 and 20 cm for the HTE version, guarantees improved product layout on painted parts.

SUITCASE

All spray guns of the Walcom® range are supplied in easy to use rigid plastic cases containing all the accessories for a proper cleaning and maintenance of the product.



- 1 AIR ADJUSTMENT**
Completely open for total air flow.
- 2 AIR INLET PRESSURE**
2 bar for opaque base (H₂O and solvent) transparent and pastel MS-HS-UHS.
- 3 FAN PATTERN CONTROL**
Completely open for ideal paint atomization.
- 4 MATERIAL FLOW CONTROL**
3.5 turns. Subjective value and therefore modifiable according to the user's habits.



TYPE

ITEM ID

RECOMMENDED USE

EGO HTE

2 Cups: POM C 75-180 cc

Cup: aluminium 125 cc

- Body: forged and chrome-plated aluminium
- Air cap: chemical nickel-plated brass
- Nozzle: AISI 303 stainless steel
- Needle-spring: stainless steel
- Seal gaskets: self-lubricating and adjustable PTFE (Teflon)
- Weight: 295 g
- Operating air pressure: 2.0 - 2.5 bar
- Air consumption: 150 - 190 l/min
- Ø nozzle: 0.5 - 0.7 - 1.0 - 1.2 - 1.4

Top air inlet pressure regulator with pressure gauge

Ref. 10090**

Ref. 10091**



Note:
add nozzle Ø to Ref. (**)



EGO HVLP

2 Cups: POM C 75-180 cc

Cup: aluminium 125 cc

- Body: forged and chrome-plated aluminium
- Air cap: chemical nickel-plated brass
- Nozzle: AISI 303 stainless steel
- Needle-spring: stainless steel
- Seal gaskets: self-lubricating and adjustable PTFE (Teflon)
- Weight: 295 g
- Operating air pressure: 2.0 - 2.5 bar
- Air consumption: 150 - 190 l/min
- Ø nozzle: 0.5 - 0.7 - 1.0 - 1.2 - 1.4

Top air inlet pressure regulator with pressure gauge

Ref. 10023**

Ref. 10024**



Note:
add nozzle Ø to Ref. (**)



GRAFO BAG

Kit for professional decorator packed in suitcase.

Ref. 39000/W

Featuring:

- 1 airbrush GRAPHIQUE
- 1 spray gun EGO HVLP Ø 0.7 with POM C gravity cup capacity 75 cc
- 1 needle-nozzle-air cap kit Ø 1.0 HVLP
- 1 DECOR KIT
- 1 air hose Ø 4x6 1.5 m with fittings
- Weight: 1.915 Kg
- Plastic suitcase



GRAPHIQUE

Professional double action airbrush designed for all graphic works and decoration **Ref. 39003/W**

- Body: nickel-plated brass
- Weight: 300 g
- Nozzle: stainless steel
- Operating air pressure: 0.5 - 3.5 bar
- Needle-springs: stainless steel
- Air consumption: 10 - 25 l/min
- Double cups - gravity cup in anodized aluminium capacity 4 cc; suction cup in glass capacity 20 cc
- Featuring: fitting for hose Ø 4x6 - service spanner - support.



DECOR KIT

Ref. 34500/W

Ideal for the simultaneous use of more than one product with the EGO HTE/HVLP spray gun.

- Featuring: 5 glass cups, capacity 20 cc; adaptor for EGO HTE/HVLP to be screwed on the body
- Weight: 210 g



In order to clean your spray gun more rapidly, we suggest that you reserve a cup for the diluent



MATIK automatic spray guns

IDEAL FOR WATERBORNE AND SOLVENT BASE, MS AND HS FOR INDUSTRIAL, WOODWORKING AND BODY SHOP.

Innovative automatic spray gun for industrial painting.

With a new design, MATIK combines the high product atomization features with the needs typical of the automatic painting sector such as component durability and extreme maintenance ease.

In fact, MATIK combines highly atomizing caps, from the bodywork sector, with perfect needle interference on the nozzle which, with CNC machine processed body and components, guarantee efficiency, reliability and durability. Available in the MATIK GEO versions, thus ecological with double atomization nozzle recommended for Car Re-finish; MATIK HVLP, recommended for industrial and wood applications; MATIK HTE, the high transfer efficiency version with high atomization, ideal for any type of application.

MATIK is engineered for easy maintenance but at the same time to deliver the best available performance with micrometric paint flow adjustment, all the models are available with 3 or 4 controls (the difference is in the pneumatic return needle control).

PAINTING DISTANCE

10-15 cm for HVLP and 15-20 cm for HTE for a correct application.

BOX

The MATIK series are conveniently packed in structure cardboard box, high protection type. In the package is included: pneumatic fitting and couplers for the connection to the air system and the usual kit for cleaning and maintenance.

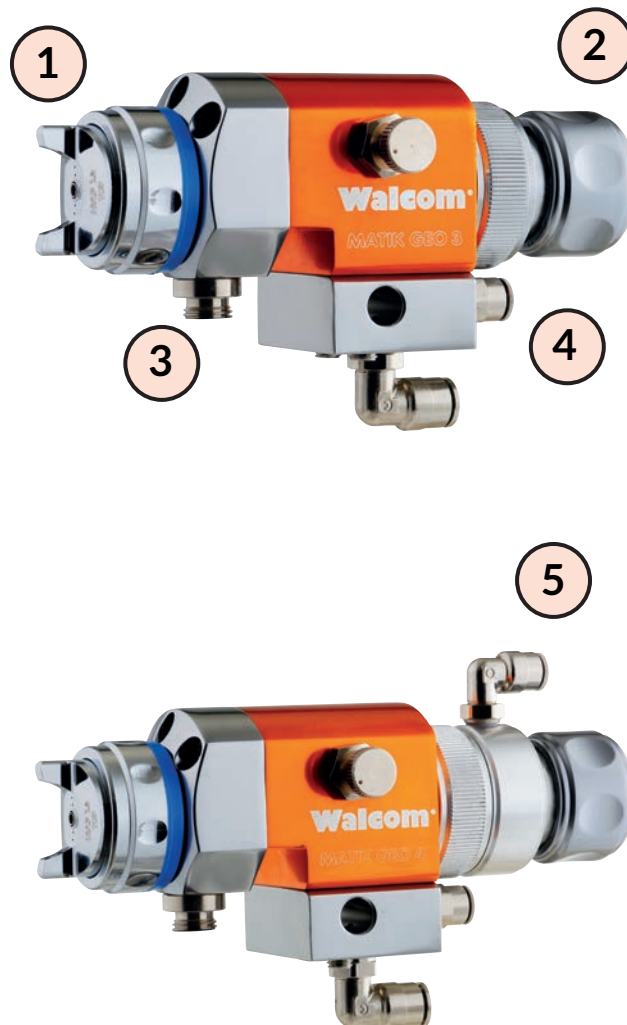

- 1 ATOMIZATION**
The Walcom® tradition for extremely high performance levels.
- 2 ADJUSTMENTS**
Air, product, pressure, fan.
- 3 MAINTENANCE**
Practical and function, the needle-nozzle and cap KIT can be quickly replaced.
- 4 SEAL**
Spray gun constructed with materials that guarantee maximum durability, even in extreme use conditions.
- 5 MATIK 4**
Needle pneumatic return control.



TYPE

ITEM ID

RECOMMENDED USE

MATIK HTE 3

Ref. 3280**



- Air and control inlets: with rotary quick couplings (M 1/4" double product inlet)
- Body: extruded anodised aluminium
- Air cap: nickel-plated brass
- Nozzle: AISI 303 stainless steel
- Needle-spring: stainless steel
- Spring return needle closing
- Seal gaskets: self-lubricating PTFE (Teflon)
- Fan and needle opening adjustments: micrometric and independent
- Weight: 890 g
- Operating air pressure: 2.0 bar
- Air consumption: 250 l/min
- Ø nozzle: 0.8 - 1.0 - 1.2 - 1.4 - 1.7

MATIK HTE 4

Ref. 3285**

Same features as Matik HTE 3 except:

- Pneumatic return needle closing
- Weight: 983 g

Note:
add nozzle Ø to Ref. (**)



MATIK HVLP 3

Ref. 3270**



- Air and control inlets: with rotary quick couplings (M 1/4" double product inlet)
- Body: extruded anodised aluminium
- Air cap: nickel-plated brass
- Nozzle: AISI 303 stainless steel
- Needle-spring: stainless steel
- Spring return needle closing
- Seal gaskets: self-lubricating PTFE (Teflon)
- Fan and needle opening adjustments: micrometric and independent
- Weight: 890 g
- Operating air pressure: 2.0 bar
- Air consumption: 250 l/min
- Ø nozzle: 0.8 - 1.0 - 1.2 - 1.4 - 1.7

MATIK HVLP 4

Ref. 3275**

Same features as Matik HVLP 3 except:

- Pneumatic return needle closing
- Weight: 983 g

Note:
add nozzle Ø to Ref. (**)



MATIK GEO 3

Ref. 3260**



- Air and control inlets: with rotary quick couplings (M 1/4" double product inlet)
- Body: extruded anodised aluminium
- Air cap: nickel-plated brass
- Nozzle: AISI 303 stainless steel
- Needle-spring: stainless steel
- Spring return needle closing
- Seal gaskets: self-lubricating PTFE (Teflon)
- Fan and needle opening adjustments: micrometric and independent
- Weight: 890 g
- Operating air pressure: 2.0 bar
- Air consumption: 250 l/min
- Ø nozzle: 0.7 - 1.0 - 1.3 - 1.5 - 1.7

MATIK GEO 4

Ref. 3265**

Same features as Matik GEO 3 except:

- Pneumatic return needle closing
- Weight: 983 g

Note:
add nozzle Ø to Ref. (**)



main spray gun SPARE PARTS

Walcom® original spare parts for a correct product maintenance are essential to keep the proper tool performance. Kit ADC (nozzle - needle air cap), Kit SPB the spare part box with the most frequent parts, Kit seals and springs (re-build kit) included in each package or available separate.

A wide range of cups for spraygun, gravity, suction available in different materials and versions.

The new ANTI UV POM black cup, ideal solution for latest generation paint with fast drying times.



ORIGINAL

We recommend using only original spare part for a proper and efficient functionality of our products. The usage of not original spare parts can create malfunctioning but also damage the product itself.

PACKAGING

All our products are packed in cardboard box, plastic case or blister, with a barcode system and item ID number.

Delicate spare parts are carefully packed to avoid any transport damages.

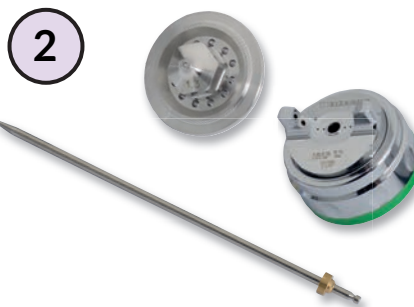

1 SPB SPARE PARTS BOX
All the main spare parts enclosed in a practical box, for safe and orderly maintenance.

2 ADC KIT
Needle, nozzle and cap, essential spare parts for correct spray gun operations.

3 CUPS
Complete range of POM C, aluminium, pressurised, upper and lower cups.

4 ANTI UV CUP
The use of a specific compound during the injection process, prevents UV rays to penetrate the cup and it represents the perfect solution for the new fast drying paint materials.



COMPATIBILITY

Always replace with part specific for your model.

If the thread is the same dimension, it could be not compatible with your product by default.

Not using the proper part may seriously compromise the performance of your product.

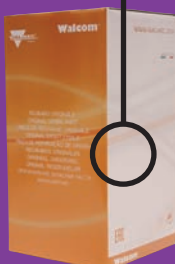

The ADC KIT contains needle-nozzle-air cap for the following models:

**GENESI
CARBONIO**

Genesi Carbonio HTE

ITEM ID	Ø	ITEM ID	Ø
Base		Clear	
970010	1.0	960011	1.1
970012	1.2	960012	1.2
970013	1.3	960013	1.3
970014	1.4	960014	1.4
970017	1.7	960017	1.7
970019	1.9	960019	1.9

Genesi Carbonio HVLP

ITEM ID	Ø
980010	1.0
980012	1.2
980013	1.3
980014	1.4
980015	1.5
980017	1.7
980019	1.9

Genesi Carbonio GEO

ITEM ID	Ø
990010	1.0
990012	1.2
990013	1.3
990014	1.4
990015	1.5
990017	1.7
990019	1.9

**GENESI
Top Line**

Genesi Top Line HTE

ITEM ID	Ø
956010	1.0
956012	1.2
956013	1.3
956014	1.4
956017	1.7
956019	1.9

Genesi Top Line HVLP

ITEM ID	Ø
946010	1.0
946012	1.2
946013	1.3
946014	1.4
946017	1.7
946019	1.9

Genesi Top Line GEO

ITEM ID	Ø
936010	1.0
936013	1.3
936015	1.5
936017	1.7
936019	1.9

SLIM

Slim S-I-SP-HD HTE
Slim S-I-SP-HD HTE SR

ITEM ID	Ø
1135210	1.0
1135212	1.2
1135213	1.3
1135215	1.5
1135217	1.7
1135219	1.9
1135222	2.2
1135225	2.5

Slim S-I-SP-HD
HVLP

ITEM ID	Ø
1135010	1.0
1135013	1.3
1135015	1.5
1135017	1.7
1135019	1.9
1135022	2.2

EGO HTE		EGO HVLP	
ITEM ID	Ø	ITEM ID	Ø
410005	0.5	41370	0.5
410007	0.7	41371	0.7
410010	1.0	41372	1.0
410012	1.2	41373	1.2
410014	1.4	41374	1.4

EGO

**Automatic
spray guns**

MATIK HTE
3-4

ITEM ID	Ø
375508	0.8
375510	1.0
375512	1.2
375514	1.4
375517	1.7

MATIK HVLP
3-4

ITEM ID	Ø
375408	0.8
375410	1.0
375412	1.2
375314	1.4
375317	1.7

MATIK GEO
3-4

ITEM ID	Ø
375307	0.7
375310	1.0
375313	1.3
375315	1.5
375317	1.7

SPARE PARTS BOX

Plastic packaging containing the parts most subject to wear in the spray gun; 16 spare parts that assist the user's work. Reference, nºpieces and position in spare parts diagram are indicated in the box with a numbered grid that guides the professional searching for the required spare part.

TYPE	ITEM ID
Spare parts box GENESI CARBONIO	Ref. 90185
Spare parts box GENESI Top Line	Ref. 90141
Spare parts box SLIM	Ref. 90139
Spare parts box EGO	Ref. 90143

Size: L 24 x P 18 x H 3.5 cm

Weight: 480 g Genesi Carbonio/ Genesi Top Line - 437 g Slim - 378 g Ego



SET OF GASKETS

Set of gaskets includes: springs, rod, air valve for spray guns.

TYPE	ITEM ID
GENESI all models	Ref. 1011270
SLIM all models	Ref. 40761
EGO HTE / HVLP	Ref. 1011262
MATIK all models	Ref. 40816

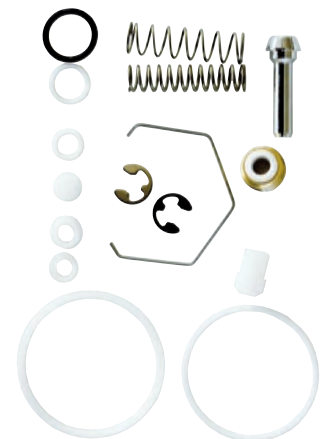

Adaptor

Ref. 52018

Made of nickel-plated brass to fit the new 680 cc POM C cup for Genesi (Ref. 52028/B - 52028/F - 52028/UV) with all types of spray guns in our range.



GRAVITY CUPS:

TYPE

ITEM ID

POM C 680 cc / Genesi Carbonio-Top Line

680 cc POM C gravity cup - weight: 170 g

Ref. 52028/B

Ø 9 product passage hole - M 16x1.5 thread

Valid for models:

Genesi Carbonio HTE, HVLP, GEO and Genesi Top Line HTE, HVLP, GEO

NYLON 680 cc / Genesi Carbonio-Top Line

Nylon clear smoke effect cup 680 cc - Weight 147 g

Ref. 52028/F

Ø 9 product passage hole - M 16x1.5 thread

Valid for models:

Genesi Carbonio HTE, HVLP, GEO and Genesi Top Line HTE, HVLP, GEO

POM C 680 cc UV / Genesi Carbonio-Top Line

POM C plastic grey cup anti UV 680 cc - Weight 170 g

Ref. 52028/UV

Ø 9 product passage hole - M 16x1.5 thread

Valid for models:

Genesi Carbonio HTE, HVLP, GEO and Genesi Top Line HTE, HVLP, GEO

POM C 680 cc / Slim

680 cc POM C gravity cup - weight: 235 g

Ref. 52010/W

POM C plastic grey cup anti UV 680 cc - Weight 170 g

Ref. 52010/UV

Ø 6.8 product passage hole - M 12x1 thread

Valid for models:

Slim HTE, Slim HVLP, Slim, Ego HTE/HVLP

POM C 75-180 cc / Ego

75 cc POM C gravity cup - weight: 50 g

Ref. 52015/W

180 cc POM C gravity cup - weight: 100 g

Ref. 52014/W

POM C plastic grey cup anti UV 180 cc - Weight 100 g

Ref. 52014/UV

Valid for models:

Ego HTE/HVLP, Slim HTE, Slim HVLP, Slim

Cups mod. Graphique

20 cc glass suction cup - weight 30 g

Ref. 52039

4 cc anodized aluminium gravity cup - weight 10 g

Ref. 51040/W



GRAVITY CUPS:

TYPE

ITEM ID

ALU. 750 cc / Genesi Carbonio-Top Line

750 cc aluminium gravity cup - weight: 158 g

Ref. 52008/W

Valid for models:

Genesi Carbonio HTE, HVLP, GEO and Genesi Top Line HTE, HVLP, GEO**ALU. 750 cc / Slim**

750 cc aluminium gravity cup - weight: 158 g

Ref. 52005/W

Valid for models:

Slim HTE, Slim HVLP, Slim and Ego HTE, HVLP**ALU. 500 cc / Slim**

500 cc aluminium gravity cup - weight: 116 g

Ref. 52007/W

Valid for models:

Slim HTE, Slim HVLP, Slim and Ego HTE, HVLP**ALU. 125 cc / EGO**

125 cc aluminium gravity cup - weight: 65 g

Ref. 52016/W

Valid for models:

Ego HTE, HVLP

SUCTION CUP: camlock and bayonet cups for suction spray guns

TYPE

ITEM ID

Camlock 1000 cc / Genesi Top Line

1000 cc complete anodized aluminium suction cup with cover - weight: 428 g

Ref. 51008/W

Valid for models:

Genesi Top Line HTE, HVLP and GEO

1000 cc anodized aluminium suction cup only - weight: 225 g

Ref. 20100102083

Set of camlock cup gaskets (5 pieces)

Ref. 90119/W



Camlock 1000 cc / Slim

1000 cc complete anodized aluminium suction cup with cover - weight: 450 g

Ref. 51012/W

Valid for models:

Slim HTE, Slim HVLP, Slim

1000 cc anodized aluminium suction cup only - weight: 225 g

Ref. 20100102083

Set of camlock cup gaskets (5 pieces)

Ref. 90119/W



Bayonet 1000 cc / Slim

1000 cc complete anodized aluminium suction cup with cover - weight: 357 g

Ref. 51007

Valid for models:

Slim HTE, Slim HVLP, Slim

1000 cc anodized aluminium suction cup only - weight: 155 g

Ref. 20100568083

Set of bayonet cup gaskets (5 pieces)

Ref. 90120/W



PRESSURIZED GRAVITY CUP: for high-density products

Pressurized gravity cup / Genesi Carbonio-Top Line

680 cc POM C gravity cup set complete with air flow regulator with manometer.

For high density products like: latex, polyurethanes, gel coat, thixotropic products

etc. - weight 560 g

Ref. 52055/W

Valid for models:

Genesi Carbonio HTE, HVLP, GEO, Genesi Top Line HTE, HVLP and GEO

Pressurized gravity cup / Slim

680 cc POM C gravity cup set complete with air flow regulator with manometer.

For high density products like: latex, polyurethanes, gel coat, thixotropic products

etc. - weight 560 g

Ref. 52054/W

1000 cc aluminium cup version - weight: 580 g

Ref. 52053/W

Valid for models:

Slim HTE, Slim HVLP, Slim

Couplings and plugs

COMPATIBLE PLUGS

STANDARD

X300 U

X300 U universal automatic coupling

Body: nickel-plated brass/
aluminium
Tip: PA66 loaded glass with
aluminium ring
Air valve: brass
Lock: 6-ball steel
Gaskets: NBR

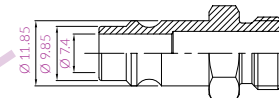
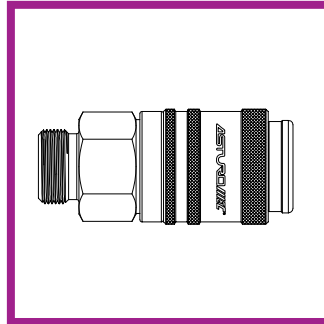
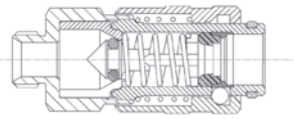

D

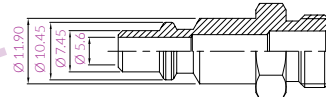

I

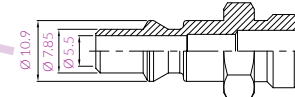

S

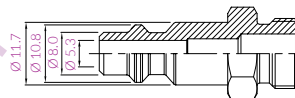

USA

X300 U

X300 automatic coupling

Body: nickel-plated brass/
anodised aluminium
Tip: PA66 loaded glass with alu-
minium ring
Air valve: brass
Lock: 6-ball steel
Gaskets: NBR

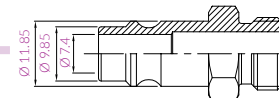
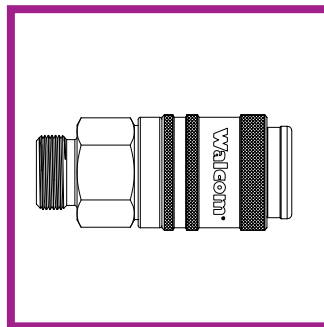
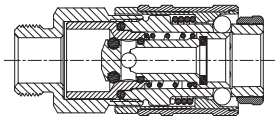

D

X400

X400 semi-automatic coupling

Body: nickel-plated brass/
tempered and chrome-plated
steel
Tip: nickel-plated brass
Air valve: tropicalized steel
Lock: 4-ball steel
Gaskets: NBR

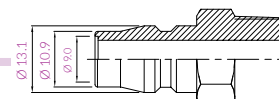
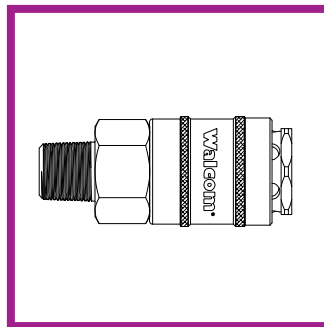
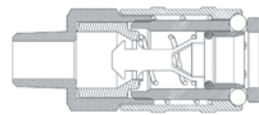

Jp

TECHNICAL SPECIFICATIONS:

Professional coupling and plugs and high air flow fittings for bodywork use. Japanese (diam. 9.2 mm) and German (diam. 7.4 mm) standards guarantee constant air flow between hose and spray gun, without choking, and air flow over 1.500 l/min at 6 bar.

Operating air pressure: 0 - 16 bar
Working temperature: -40°C + 80°C

- Standard D
- Standard I
- Standard S
- Standard USA
- Standard X400 AUT

QUICK COUPLING FLOW DIAGRAM WITH 1 bar

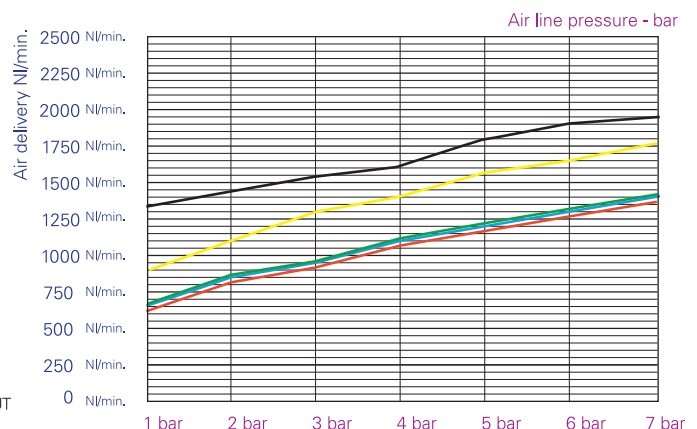

TYPE

ITEM ID

X300 U - Male

Thread 1/4"	Ref. 10201U
Thread 3/8"	Ref. 10202U
Thread 1/2"	Ref. 10203U

Package: 25 pcs

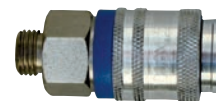

X300 U - Female

Thread 1/4"	Ref. 10211U
Thread 3/8"	Ref. 10212U
Thread 1/2"	Ref. 10213U

Package: 25 pcs



X300 U - With rest

Internal diameter 6 mm	Ref. 10221U
Internal diameter 8 mm	Ref. 10222U
Internal diameter 10 mm	Ref. 10223U

Package: 25 pcs



X300 U - For rubber hose

Internal diameter 6 mm - External diameter 14 mm	Ref. 10231U
Internal diameter 8 mm - External diameter 17 mm	Ref. 10232U
Internal diameter 10 mm - External diameter 19 mm	Ref. 10233U
Internal diameter 8 mm - External diameter 14 mm	Ref. 10234U

Package: 25 pcs

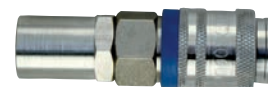

X300 U -For rubber hose

Thread 6x8	Ref. 10241U
Thread 8x10	Ref. 10242U
Thread 6x10	Ref. 10243U
Thread 8x12	Ref. 10244U
Thread 10x12	Ref. 10246U

Package: 25 pcs



TYPE

ITEM ID

X300 - Male

Thread 1/4"	Ref. 10251
Thread 3/8"	Ref. 10252
Thread 1/2"	Ref. 10253

Package: 10 pcs



X300 - Female

Thread 1/4"	Ref. 10261
Thread 3/8"	Ref. 10262
Thread 1/2"	Ref. 10263

Package: 10 pcs



X300 - With rest

Internal diameter 6 mm	Ref. 10271
Internal diameter 8 mm	Ref. 10272
Internal diameter 10 mm	Ref. 10273

Package: 10 pcs



X300 - D male plug

Thread 1/4"	Ref. 11041
Thread 3/8"	Ref. 11042
Thread 1/2"	Ref. 11043

Package: 25 pcs



X300 - D female plug

Thread 1/4"	Ref. 11141
Thread 3/8"	Ref. 11142

Package: 25 pcs



TYPE

ITEM ID

X400 - Male

Thread 1/4" U
Thread 3/8" U

Ref. 10551
Ref. 10552

Package: 10 pcs

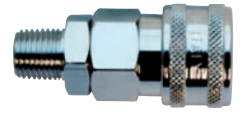

X400 - Female

Thread 1/4" U
Thread 3/8" U

Ref. 10651
Ref. 10652

Package: 10 pcs



X400 - With rest

Internal diameter 8 mm
Internal diameter 10 mm

Ref. 10555
Ref. 10556

Package: 10 pcs



X400 - Jp male plug

Thread 1/4" U
Thread 3/8" U

Ref. 11470
Ref. 11471

Package: 10 pcs



X400 - Jp female plug

Thread 1/4" U
Thread 3/8" U

Ref. 11480
Ref. 11481

Package: 10 pz.



painting ACCESSORIES

Professional accessories designed to facilitate bodyworks, guaranteeing maximum efficiency and practicality, demonstrating that even details are important in quality works. A complete ranges, from regulators to masks, clothing to Personal Protection Equipment, specific paint booth hoses and paint filters.
All this designed and manufactured by Walcom exclusively for professionals.

High quality accessories
line made in Italy



- ① **MASKS**
Active carbon or dust-proof, they offer suitable respiratory tract protection.
- ② **PAPER SIEVE**
Practical, efficient, disposable sieve for correct paint filtering.
- ③ **SUPPORT**
Valid supports for 1 or 2 spray guns with upper cup, booth wall mountable with a supplied magnet or screws (Supporter), and bench top (Skeleton).
- ④ **MASK**
Complete with helmet, visor and internal air regulator; required for workman's safety in the paint booth.



PACKAGING

All our accessories are packed in safe box, plastic bag with hook system, configure to be easily stocked on shelves or grid stand.



- ⑤ **OVERALLS**
Made of nylon with an anti-static finish, it is the solution required to work in the paint booth. The anti-static finish makes it paint fume repellent.
- ⑥ **GLOVES**
Made of latex, paint and solvent resistant, they let the operator work in fully clean conditions.
- ⑦ **VISCOSIMETRO**
Indispensable in hosta-form to check density, commonly called the "Ford 4 cup" by workers.

TYPE

ITEM ID

Carbon fiber air regulator DGT

Pressure regulator with precise high flow valve, carbon fiber housing and 1/4" swiveling connection. Digital gauge with carbon fiber housing.

Ref. 90183/W

- Body: carbon fiber
- Gauge: digital high precision, carbon fiber housing
- Range: 0 - 12 bar (can be easily changed to psi)
- Air inlet: 1/4" U swiveling, compatible with different 1/4 standard version
- **EJS sytem (easy joint system) automatic coupler, practical and fast manometer connection and disconnection**

- Package: 1 pcs
- Weight: 118 g



Carbon fiber air regulator

Air pressure regulator, high flow and precise, carbon fiber housing and 1/4" swiveling connection.

Ref. 90184/W

- Body: carbon fiber
- Air inlet: 1/4" swiveling, compatible with different 1/4 standard version
- Package: 1 pcs
- Weight: 77 g



Carbon fiber air regulator DGT / Adjustable angle

Pressure regulator with precise high flow valve, carbon fiber housing and 1/4" swiveling connection and adjustable angle. 30°. Digital gauge with carbon fiber housing.

Ref. 90180/W

- Body: carbon fiber
- Gauge: digital high precision, carbon fiber housing
- Range: 0 - 12 bar (can be easily changed to psi)
- Air inlet: 1/4" U swiveling, compatible with different 1/4 standard version. Adjustable 30° angle connection
- **EJS sytem (easy joint system) automatic coupler, practical and fast manometer connection and disconnection**

- Package: 1 pcs
- Weight: 127 g



Carbon fiber air regulator / Adjustable angle

Air pressure regulator, high flow and precise, carbon fiber housing and 1/4" swiveling connection.

Ref. 90182/W

- Body: carbon fiber
- Air inlet: 1/4" swiveling, compatible with different 1/4 standard version, adjustable 30° angle connection
- Package: 1 pcs
- Weight: 86 g



Digital carbon fiber gauge DGT

Digital gauge high precision, carbon fiber housing.

Ref. 90181/W

- **EJS sytem (easy joint system) automatic coupler, practical and fast manometer connection and disconnection.**
- Range: 0 - 12 bar (can be easily changed to psi)
- Package: 1 pcs.
- Weight: 41 g



TYPE

ITEM ID

Top regulator

High flow and precision regulator with glass pressure gauge and metallic case to be applied to the spray gun air inlet.

Ref. 90147/W

- Body: CNC processed anodised aluminium
- Gauge: range 0 - 10 bar
- Air inlet: 1/4" U compatible with various standard 1/4"
- Package: 1 pcs
- Weight: 140 g



Top regulator

High flow and precision regulator to be applied to the spray gun air inlet.

Ref. 90148/W

- Body: CNC processed anodised aluminium
- Air inlet: 1/4" U compatible with various standard 1/4"
- Package: 1 pcs
- Weight: 70 g



Regulator

Air flow regulator with glass pressure gauge and metallic case to be applied to the spray gun air inlet.

Ref. 90105/W

- Gauge: range 0 - 10 bar
- Air inlet: 1/4" U compatible with various standard 1/4"
- Package: 1 pcs
- Weight: 138 g



Regulator

Air flow regulator to be applied to the spray gun air inlet.

Ref. 90106/W

- Air inlet: 1/4" U compatible with various standard 1/4"
- Package: 1 pcs
- Weight: 68 g



Gauge

Spare gauge for air flow regulator, connection M 1/8"

Ref. 61306

- Operating air pressure: 0 - 10 bar
- Package: 1 pcs - weight: 70 g

Gauge protector from 39 to 43 mm

Ref. 90128

Gauge protector from 63 mm

Ref. 90129

Transparent shockproof and paint-proof pressure gauge guard, washable with solvent

- Package: 10 pcs
- Weight: 10 g

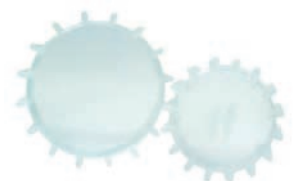

TYPE

ITEM ID

HELMET mask

Approved protective mask CE0194 approved - EN1459N:2005 class A standard compliant consisting of:

Ref. 50400/W

- visored helmet with internal ventilation
- pressure drop safety buzzer
- polyurethane hose for spray gun connections
- filtering kit with carbon filters
- belt
- 2 spare adhesive visor cover
- Package: 1 pcs
- Weight: 1.2 Kg



SAFETY PLUS mask

Protective mask with 2 active carbon filters
Spare filter for Ref. 50410/W - weight 100 g

Ref. 50410/W

Ref. 50411/W

- Meet EEC standards, 89/686/EEC directive
- Package: 1 pcs
- Weight: 320 g



SAFETY mask

Protective mask with 1 active carbon filter
Spare filter for Ref. 50416/W - weight 100 g

Ref. 50416/W

Ref. 50417/W

- Meet EEC standards, 89/686/EEC directive
- Package: 1 pcs
- Weight: 280 g



Paint mask

FFP2S active carbon filter face mask, suited for painting.

Ref. 50418/W

- Package: 10 pcs
- Weight: 260 g



Dust mask

FFP1 dust-proof filter face mask.

Ref. 50419/W

- Package: 50 pcs
- Weight: 160 g



TYPE

ITEM ID

Goggles

V-Maxx protective goggle mask with AC lenses + 2 lens covers

Ref. 50420/W

- Package: 5 pcs
- Weight: 375 g



Painting overall

- ① Painting suit for the spray booth, manufactured with white anti static breathable nylon material. Single pocket. **Ref. ARC041/****

- ② High quality suit to be used inside the spray booth, antistatic, breathable and elastic fit. Grey reinforced nylon, double pocket and flexible and comfortable arm design. **Ref. ARC177/****

Features:

- Sizes: 52 - 54 - 56 (** add size numberto the item id)

- Package: 1 pcs

- Weight: : 155 - 160 g



Gloves

Latex, non-sterile ambidextrous paint gloves.
Paint and solvent resistant.

Ref. 50421/W

- One size fits all
- Package: 50 pcs
- Weight: 2 Kg



Gloves

Disposable painter gloves, back nitrile, durable, comfortable fit and high textile resistance. Dust, latex and silicon free.

Ref. 50422/**

- Taglia: L - XL (** add size numberto the item id)
- Package: 60 pcs
- Weight: 2.1 Kg



Articulated fitting

F 1/4"nickel-plated brass fitting with 30° joint, ideal for painting.

Jp standard Japanese version *

Ref. 11048

D standard German version **

Ref. 11049

- Package: 10 pcs
- Weight: *680 g - ** 640 g



TYPE

ITEM ID

Supporter

Magnetic holder for spray guns with gravity cups.
Can also be affixed to non-ferrous surfaces using supplied screws.

Ref. 60130

Features:

- Painted steel
- Package: 1 pcs
- Dimensions cm: L 20 x P 14.5 x H 23.2 cm
- Weight: 1.68 Kg



Skeleton

Holder for spray guns with gravity cups. Simple, stable and ergonomic, suited for any spray gun.

Ref. 60149/W

Features:

- Galvanised steel
- Dimensions cm: L 13 x P 20 x H 29 cm
- Package: 1 pcs
- Weight: 177 g



Cleaning kit

Cleaning set indispensable for spray gun maintenance.

Ref. 90109/W

Composition:

- 1 pin;
- 1 big cleaning brush;
- 1 small cleaning brush;
- 12 pins for cleaning the air cap.
- Package: 1 Kit
- Weight: 30 g



Wrench set

Set of wrench for the maintenance on "FX-FZ" spray gun series.

Ref. 91000

- Package: 6 pcs
- Weight: 830 g



SSP2

2 l capacity pressurised tank with M M 1/4" product inlet/outlet.

Ref. 90014

- Container: anodized aluminium
- Safety valve: brass
- Doubled hose: SBR/EPDM rubber with fittings; 1.5 m length
- Air inlet pressure regulator with manometer
- Operating air pressure: 1.0 bar max
- Air consumption: 3.0 bar
- Weight: 1.8 Kg



TYPE

ITEM ID

Filter

Steam trap filter with filler component and steam release valve to be fitted at the inlet of the spray gun.

Ref. 90111/W

- Package: 1 pcs
- Weight: 100 g



Filter

100-mesh (750 µm) complete filter for pressure fed spray guns, **F/M 3/8"** version*

Ref. 60097/W

100-mesh (750 µm) complete filter for pressure fed spray guns, **F/M 1/4"** version *

Ref. 60098/W

100-mesh (750 µm) complete filter for Ref. 60097/W **

Ref. 412012/W

- * Package: 1 pcs = Weight: 50 g
- ** Package: 1 pcs = Weight: 25 g



Filter

2000-mesh (160 µm) stainless steel paint filter to be attached to the suction pipe of spray guns with suction cups.

Ref. 90112/W

- Package: 10 pcs
- Weight: 50 g



Filter

Nylon paint filter to be attached to the suction pipe of spray guns with suction cups.

Ref. 90113**/W

** Specify: 5000 - 7000 - 10000 mesh (90 µm-75 µm-60 µm)

- Package: 10 pcs
- Weight: 65 g



Filter

2000-mesh (160 µm) nylon paint filter to be attached to the spray gun with gravity cups for touch-ups

Ref. 90114/W

500-mesh (300 µm) nylon paint filter to be attached to the spray gun with gravity cups for primers

Ref. 90137/W

- Package: 10 pcs
- Weight: 40 g



TYPE

ITEM ID

Genesi Carbonio / Genesi Top Line filter

800-mesh (230 µm) nylon paint filter to be attached to the spray guns with gravity cups. **Ref. 90145/W**

- Package: 10 pcs
- Weight: 40 g



Sieve

Nylon sieve for paint

Ref. 90115/W**

** Specify: 2000 - 5000 - 7000 - 10000 - 15000 - 17000 mesh
(160 µm-90 µm-75 µm- 60 µm-45 µm-40 µm)

- Package: 10 pcs
- Weight: 300 g



Paper sieve

Disposable paper paint sieve.

1000 mesh version (190 µm)

Ref. 90146.10

2500 mesh version (125 µm)

Ref. 90146.25

- Package: 250 pcs
- Weight: 1.473 Kg



Viscosimeter

"FORD 4" viscosimeter cup to test paint density.

Ref. 90116/W

- Package: 3 pcs
- Weight: 270 g



Supermix

Undulated plastic mixer stick with holes, specific to mix paint properly
To be sued with cups up to 1400 ml.

Ref. 90186/W

- 200 pieces per package



PAINTING HOSES

Professional range of hoses specific to paint booths, also available in the practical 10/12 metre coupled versions. In addition to the high performance Polyurethane and flexible Ragno, already popular and appreciated on the market, a new Walcom® SUPERFLEX hose is introduced with high performance in terms of sturdiness, durability, seal, temperature resistance and flexibility: ideal for safe painting in the booth.

TYPE

ITEM ID

SUPERFLEX

High performance and resistance hose, PU (Polyurethane) composite and thermoplastic rubber, reinforced with polyester. Antistatic.

100 m coil

- Bottom layer and cover: PU composite and thermoplastic rubber
- Reinforcing: polyester fiber
- Operating air pressure: 15 - 20 bar
- Exploding pressure: 60 bar
- Temperature: - 15°C + 70°C

Internal diameter 10 mm - external diameter 15 mm

Ref. 60307

- Package: 1 pcs



SUPERFLEX

High performance and resistance hose, PU (Polyurethane) composite and thermoplastic rubber, reinforced with polyester. Antistatic.

12 m coil

- Bottom layer and cover: PU composite and thermoplastic rubber
- Reinforcing: polyester fiber
- Operating air pressure: 15 - 20 bar
- Exploding pressure: 60 bar
- Temperature: - 15°C + 70°C

Internal diameter 10 mm - external diameter 15 mm

Ref. 60309

- Package: 1 pcs



STRAIGHT POLYURETHANE

100 m coil

- Substrate and cover: 100% polyurethane
- Reinforcement: 550/1100 Trevira Heochst polyester yarn
- Operating air pressure: 20 bar
- Exploding pressure: 60 bar
- Temperature: - 25°C + 60°C

Internal diameter 6 mm - external diameter 10 mm

Ref. 60200

Internal diameter 8 mm - external diameter 12 mm

Ref. 60201

Internal diameter 10 mm - external diameter 14.5 mm

Ref. 60202

- Package: 1 pcs



TYPE

ITEM ID

STRAIGHT POLYURETHANE

10 m coil with 2 swiveling female 1/4" fittings

- Substrate and cover: 100% polyurethane
- Reinforcement: 550/1100 Trevira Hoechst polyester yarn
- Operating air pressure: 20 bar
- Exploding pressure: 60 bar
- Temperature: - 25°C + 60°C

Internal diameter 6 mm - external diameter 10 mm

Ref. 60210

Internal diameter 8 mm - external diameter 12 mm

Ref. 60211

Internal diameter 10 mm - external diameter 14.5 mm

Ref. 60212

- Package: 1 pcs



STRAIGHT POLYURETHANE

25 m coil with 2 swiveling female 1/4" fittings.

- Substrate and cover: 100% polyurethane
- Reinforcement: 550/1100 Trevira Hoechst polyester yarn
- Operating air pressure: 20 bar
- Exploding pressure: 60 bar
- Temperature: - 25°C + 60°C

Internal diameter 6 mm - external diameter 10 mm

Ref. 60220

Internal diameter 8 mm - external diameter 12 mm

Ref. 60221

Internal diameter 10 mm - external diameter 14.5 mm

Ref. 60222

- Package: 1 pcs



RAGNO HOSE

50 m coil

- Substrate and cover: polyurethane anti-abrasive and thermoplastic rubber
- Reinforcement: polyester yarn
- Operating air pressure: 20 bar
- Exploding pressure: 60 bar
- Temperature: - 20°C + 60°C

Internal diameter 10 mm - external diameter 15 mm

Ref. 60250

Internal diameter 8 mm - external diameter 12 mm

Ref. 60254

- Package: 1 pcs



RAGNO HOSE

10 m coil with fittings

- Substrate and cover: polyurethane anti-abrasive and thermoplastic rubber
- Reinforcement: polyester yarn
- Operating air pressure: 20 bar
- Exploding pressure: 60 bar
- Temperature: - 20°C + 60°C

Internal diameter 10 mm - external diameter 15 mm

Ref. 60252

- Package: 1 pcs



FILTER SERIES

Walcom® series filter groups represent the maximum expression of quality in terms of compressed air treatment in bodyworks.

Line, drop line, paint booth: perfectly clean and filtered air is a must, and for this reason Walcom® has created a complete range of single and combined filter groups, able to fully eliminate all water, oil, dust and humidity residue from mains air, generating breathable air thanks to the active carbon filter.

The new /11 series combines a restyled look with higher efficiency which, thanks to the new air passage designs, guarantees 1200 l/min air flow, allowing for efficient bodyworks with even 2 spray guns.

EXAMPLE OF THE AIR PIPING IN THE BODY SHOP

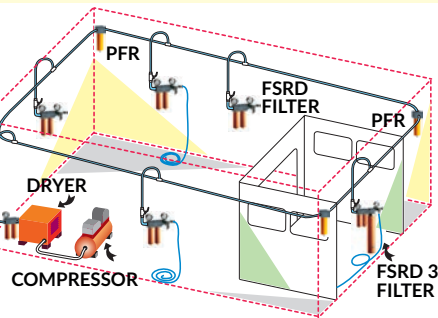

Piping inclination 0.5 - 1% max



- 1 **AIR PASSAGES**
3/4" air passages with 1200 l/min capacity. Possibility of working with 2 spray guns.
- 2 **BAR**
CNC processed extruded and anodised aluminium bar and pipes.
- 3 **PRESSURE REGULATIONS**
High precision pressure regulator with pressure gauge.
- 4 **SATURATION INDICATORS**
Silica gel saturation indicators (FSRD 4 - FSRD 3 - ESR versions).
- 5 **DISCHARGE**
Automatic for water and manual for oil.



TYPE

ITEM ID

RECOMMENDED USE

FSRD 4

A modular filter system ideal for use in the painting booth.

Ref. 60138/11



- Central body: anodized aluminium
- Composition:
 - 1) Pre-filtering element in sythentic fibre for the elimination of condensation. Automatic discharge.
 - 2) Oil-separating filter for the elimination of residual pollutants. Manual drainage tap.
 - 3) Silica dryer group to reduce residual humidity in the compressed air. Nr. 3 saturation indicator lights.
 - 4) Active carbon filter to eliminate all impurities and obtain breathable air. Max oil residue < 0.0003 mg/m³.
- Pressure adjuster: membrane system and automatic decompression
- Air inlet: F 3/4"; air outlet: n° 2 from M 1/4"
- Filtering power: air 5 µ - oil 0.01 µ
- Operating air pressure: 12 bar
- Air consumption: 1200 l/min. to 6 bar
- Weight: 11 Kg



FSRD 3

A modular filter system ideal for use in the painting booth.

Ref. 60123/11



- Central body: anodized aluminium
- Composition:
 - 1) Pre-filtering element in sythentic fibre for the elimination of condensation. Automatic discharge.
 - 2) Oil-separating filter for the elimination of residual pollutants. Manual drainage tap.
 - 3) Silica dryer group to reduce residual humidity in the compressed air. Nr. 3 saturation indicator lights.
 - 4) Filter to eliminate dust generated by silica, 5 µ filtering capacity.
- Pressure adjuster: membrane system and automatic decompression
- Air inlet: F 3/4"; air outlet: n° 2 from M 1/4"
- Filtering power: air 5 µ - oil 0.01 µ
- Operating air pressure: 12 bar
- Air consumption: 1200 l/min. to 6 bar
- Weight: 11 Kg



FSRD 2

A modular filter system ideal for use in the painting booth.

Ref. 60145/11



- Central body: anodized aluminium
- Composition:
 - 1) Pre-filtering element in sythentic fibre for the elimination of condensation. Automatic discharge.
 - 2) Oil-separating filter for the elimination of residual pollutants. Manual drainage tap.
 - 3) Active carbon filter to eliminate all impurities and obtain breathable air. Max oil residue < 0.0003 mg/m³.
- Pressure adjuster: membrane system and automatic decompression
- Air inlet: F 3/4"; air outlet: n° 2 from M 1/4"
- Filtering power: air 5 µ - oil 0.01 µ
- Operating air pressure: 12 bar
- Air consumption: 1200 l/min. to 6 bar
- Weight: 7 Kg



TYPE

ITEM ID

RECOMMENDED USE

FSRD

Air treatment system excellent for use in car-body workshops and industry.

Ref. 60121/11



- Central body: anodized aluminium
- Composition:
 - 1) Pre-filtering element in synthetic fibre for the elimination of condensation. Automatic discharge.
 - 2) Oil-separating filter for the elimination of residual pollutants. Manual drainage tap.
- Pressure adjuster: membrane system and automatic decompression
- Air inlet: F 3/4"; air outlet: n° 2 from M 1/4"
- Filtering power: air 5 µ - oil 0.01 µ
- Operating air pressure: 12 bar
- Air consumption: 1200 l/min. to 6 bar
- Weight: 4.7 Kg



FCA

Active carbon filter to eliminate all impurities and obtain breathable air, max oil residue < 0.0003 mg/m³.

Ref. 60139/11



- Central body: anodized aluminium
- Air inlet: F 3/4"; air outlet: F 1/2"
- Operating air pressure: 12 bar
- Air consumption: 1200 l/min. to 6 bar
- Weight: 2 Kg



PFR

Filter unit for the elimination of condensation.

Ref. 60127/11



- Composition: Synthetic fibre pre-filtering element to eliminate condensation. Automatic drain.
- Central body: anodized aluminium
- Pressure adjuster: membrane system and automatic decompression
- Air inlet: F 3/4"; air outlet: n° 2 from M 1/4"
- Filtering power: air 5 µ
- Operating air pressure: 12 bar
- Air consumption: 1200 l/min. to 6 bar
- Weight: 3.45 Kg



TYPE

ITEM ID

RECOMMENDED USE

ESR

Silica drying unit, to eliminate residual humidity in compressed air, to be used in combination with an air pre-filtering group in a painting booth. Provided with an indicator to show saturation of the silica which can be replaced or regenerated (4 hours at 135° C).



Ref. 60129/11

- Filter to eliminate dust generated by silica 5 µ.
- Central body: anodized aluminium
- Pressure adjuster: membrane system and automatic decompression
- Air inlet: F 3/4"; air outlet: n° 2 from M 1/4"
- Filtering power: air 5 µ
- Operating air pressure: 12 bar
- Air consumption: 1200 l/min. to 6 bar
- Weight: 11.5 Kg



THK

The kit comes in a case for scheduled FSRD4 annual equipment maintenance. **Ref. 60134**
The kit comes in a case for scheduled FSRD3 annual equipment maintenance. **Ref. 60136**



Composition:

- nr. 1 synthetic fibre water filter: to be replaced once a year;
- nr. 1 coalescent oil filter: to be replaced once a year;
- nr. 2 active carbon filters: to be replaced every 6 months (only Ref. 60134);
- nr. 1 1.3 kg silica gel package.
- Weight: 2.28 Kg FSRD4 - Weight: 2.18 Kg FSRD3



SPARE PARTS FOR AIR FILTRATION SYSTEM



① Water filter

Synthetic fiber to eliminate condensation. Filtration capacity 5 micron.

Ref. 3064087

- Package: 1 pz.
- Weight: 59 g

② Oil filter

Cartridge to eliminate oil impurities. Filtration capacity 0.01 micron

Ref. 3063162

- Package: 1 pz.
- Weight: 79 g

③ Silica gel

Silica gel beans to remove any residual humidity (it can be regenerated in 4 h at 135°C, it can last maximum 1 year).

Ref. 3063236

- Package: 1 pz.
- Weight: 1.3 Kg

④ Active charcoal

This filter remove any residual impurities, gas or vapor. Max residual <0.00003mg/m3 **Ref. 3064003A**

- Package: 1 pz.
- Weight: 8 g



— THERMODRY TECHNOLOGY —

The new TD³ PRO and TD¹ PRO multifunctional heat conditioner range is a unique and innovative compressed air conditioning system inside a paint booth that lets you work with heat regulated air and, for TD³ PRO, without any solid and gaseous impurities.

The Thermodry Technology line, equipped with the new and more powerful THT hose and rich range of accessories, now represents the top in terms of efficiency and reliability in the paint phase, based on 3 main functions:

- 1 - Air heating and thermoregulation: the TD³ PRO / TD¹ PRO heating element, combined with the THT heated hose and internal J thermocouple, heat and regulate air to allow the operator to paint at constant temperature, regardless of the climate/room conditions.

Let's not forget that air used in painting can even drop (due to air expansion) under 5°C.

TD PRO can reach temperatures between 20 and 50°C during the paint phase, essential for water-based and UHS transparent paint application, and over 70°C for drying.

Temperature which, once quickly reached, are kept constant during the entire work phase.

- 2 - Air filtering (TD³ PRO only): the full line of equipment filtering groups, water-oil-silica-active carbons, can achieve fully clean and breathable compressed air.

- 3 - Automatic dehumidifying mass regeneration (TD³ PRO only): once saturated with humidity, Silica gel requires regeneration. The TD³ PRO SRS system, due to the hot air flow inversion generated by the heating element, regenerates the entire humidifying mass in just 4 hours.



THERMODRY TECHNOLOGY: BENEFITS

Integral and efficient system use provides the following benefits:

- 1 saving up to 20% of paint material;
- 2 up to 40% drying time savings over traditional systems;
- 3 the possibility of lowering paint booth temperature by at least 5°C over that recommended by paint manufacturers;
- 4 better paint layout;
- 5 higher application speed;
- 6 elimination of brilliancy loss;
- 7 reduction of spot risks;
- 8 "orange peel" effect reduction;
- 9 full elimination of solid and gaseous impurities;
- 10 lowering of the dew point;
- 11 automatic and timed silica regeneration (TD³ PRO);
- 12 constant compressed air and hose temperature to fully guarantee system efficiency.

TD³ PRO - TD¹ PRO

The new TD³ and TD¹ multifunctional heat conditioner "PRO" line responds to user's suggestions, significantly contributing to the development of this new TD series. In fact, experience is the foundation of each product and its success, and what better advice can contribute to perfecting a tool than that from people who use it every day? Walcom, always attentive to these market inputs, has translated all this into a new efficient TD "PRO" series, with the following improvements:

- The new Tech Pro software, able to efficiently control tool operations, offers the operator the possibility of working in full safety and efficiency;
 - Doubled air flow (over 1.200 l/min) for fully efficient operations even with two spray guns;
 - The new THT hose's doubled heating power, 1.200 W, grants higher reactivity in reaching and maintaining set temperatures, with the consequent practically total reduction of operator wait time;
 - The new automatic condensation drain system, for higher cleaning and tool maintenance security.
- New and important features that further enhance this exceptional tool that has stood out as the most efficient and complete on the market.

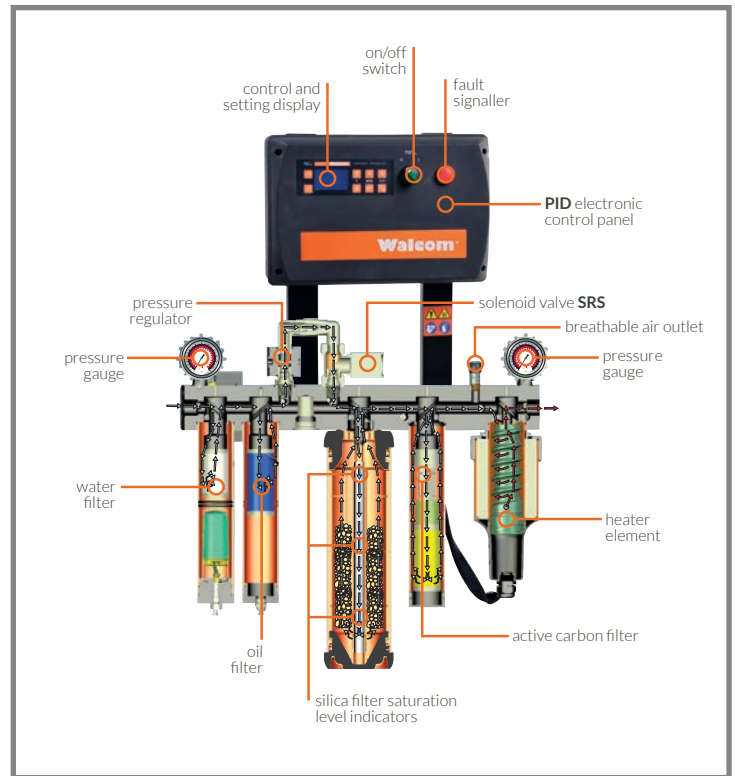

- 1 NEW SOFTWARE**
The Tech Pro version efficiently manages TD operations, controlling any system faults.
- 2 DOUBLED AIR FLOW**
The 1200 l/min air flow lets you use 2 spray guns in full efficiency.
- 3 DRAIN SYSTEM**
Automatic for water with safety rod for any clogs, manual for oil.
- 4 THT PRO**
New high performance and efficient hose with 1200 W power.

TYPE

ITEM ID

RECOMMENDED USE

TD³ PRO

Cabin booth integrated air conditioning and thermoregulation system.

Ref. 60151**



- Central body: anodised aluminium
- Composition:
 - 1) Synthetic fibre pre-filtering element that eliminates condensation. Automatic drain with safety rod for manual drain. Replace every 12 months.
 - 2) De-greaser filter to eliminate residual pollutants. Manual drain. Replace every 12 months.
 - 3) Drying group with silica gel that reduces residual humidity in compressed air. Possibility of silica gel regeneration with TD³ PRO hot air flow SRS valve. Silica gel lasts max 1 year.
 - 4) Active carbon filter to eliminate all impurities and obtain breathable air. Max oil residue < 0.0003 mg/m³. Replace every 6 months.
 - 5) Heating element with 1.200 W power controlled by an electronic unit with PID retroactive system and SCR heating power regulation.
- Pressure regulator: membrane regulation and automatic decompression
- Air inlet: F 3/4"; air outlet: F 1/2"
- Filtering power: air 5 µ - oil 0.01 µ
- Operating air pressure: 12 bar
- Air consumption: 1200 l/min to 6 bar
- Weight: 21 Kg



** Ref. /T= with 1 remote control



TD¹ PRO

Cabin booth integrated thermoregulation system.

Ref. 60152**



- Central body: anodised aluminium
- Composition:
 - 1) Heating element with 1.200 W power controlled by an electronic unit with PID retroactive system and SCR heating power regulation.
- Pressure regulator: membrane regulation and automatic decompression
- Air inlet: F 3/4"; air outlet: F 1/2"
- Filtering power: air 5 µ - oil 0.01 µ
- Operating air pressure: 12 bar
- Air consumption: 1200 l/min to 6 bar
- Weight: 6.7 Kg



** Ref. /T= with 1 remote control



THT (12 M)

Ref. 60161

THT (17 M)

Ref. 60163

THT (22 M)

Ref. 60162



Vulcanised, antistatic rubber heated air hose.

- Power: 1.200 W
- Thermoregulation: internal J thermocouple
- Dimensions: 10x15 mm - Length: 12/17/22 m
- Weight: 2.4/4/5 Kg



TYPE

ITEM ID

RECOMMENDED USE

THK

The kit comes in a case for scheduled TD³PRO annual equipment maintenance.

Ref. 60134



Composition:

- nr. 1 synthetic fibre water filter: to be replaced once a year;
- nr. 1 coalescent oil filter: to be replaced once a year;
- nr. 2 active carbon filters: to be replaced every 6 months;
- nr. 1 1.3 kg silica gel package.
- Weight: 2.8 Kg



THJ

Drying gun 70°C for basecoat.

Ref. 60133



- 40-50 cm blow distance in the first phase;
- 10-20 cm in final drying.
- Body: heatproof nylon
- Nozzle: nylon and rubber radial
- Progressive valve
- Air consumption: 265 l/min to 3 bar
- Weight: 250 g



THJ/R

Continuous flow drying gun 70°C for basecoat, equipped with air regulator.

Ref. 60150



- 40-50 cm blow distance in the first phase;
- 10-20 cm in final drying.
- Body: metallic, lined with a heatproof membrane
- Nozzle: nylon and rubber radial
- Air consumption: 265 l/min to 3 bar
- Weight: 300 g



THS

Support for nr. 4 THJ nozzles for drying at 70°C for basecoat.

Ref. 60128



- 40-50 cm blow distance in the first phase;
- 10-20 cm in final drying.
- Structure: aluminium
- Height: adjustable from 130 to 180 cm
- Tilt: adjustable from 0 to 360°
- Weight: 11.3 Kg



TYPE

ITEM ID

RECOMMENDED USE

ThRC

Remote control for TD³ PRO and TD¹ PRO heat conditioner.

Ref. 3064076



3 factory set temperatures:

- T1= 42° for opaque base
- T2= 50° for transparent
- DRY = 70° for base drying
- Temperature can be changed by the operator.
- Weight: 489 g



ThTest

High precision instrument to measure TD generated air performance.

Ref. 60154



- Temperature: output temperature measurement (post air expansion)
- Humidity: residual humidity reading
- Weight: 600 g



ThC

Painted steel TD rack structure.

Ref. 3063303



Permits easy TD³ PRO and TD¹ PRO transport and use.

- Weight: 5.2 Kg



ECODRY line

The Ecodry line includes the range of quick water-based paint drying guns and systems.

Ecodry, exploiting the Venturi system, can increase the emitted air volume by about 15 times, thus significantly reducing drying time.

The enormous generated volume of air, in fact, associated with heat taken from the paint booth (20% mains air, 80% recycled air), allows for the fast evaporation of water residue.

The range now also includes a LIGHT version made of insulating anti-static thermoplastic material for lightweight and heatproof work.

IMPORTANT: work with perfectly filtered air to avoid the infiltration of impurities that could compromise finish quality.



- 1 **NUT**
Air flow regulation nut
- 2 **BODY**
Body fully made of nylon for lighter, more practical work.
- 3 **REGULATION**
Air flow regulator for higher use precision.

TYPE

ITEM ID

RECOMMENDED USE

Ecodry

Aluminum blower gun to dry waterborne paint, adjustable flow - volume.

Ref. 60125



- Central body: anodised aluminium
- Grip: nylon
- Blow distance: 40-50 cm from the surface, continuously moving the gun
- Operating air pressure: 0.5-2.0 bar
- Air consumption: 200-300 l/min.
- Package: 1 pcs
- Weight: 550 g



Ecodry light

Super light nylon blower to dry waterborne paint, adjustable flow - volume.

Ref. 60143



- Body: nylon
- Blow distance: 40-50 cm from the surface, continuously moving the gun
- Operating air pressure: 0.5-2.0 bar
- Air consumption: 200-300 l/min.
- Package: 1 pcs
- Weight: 390 g



Air blower pro

Continuous flow drying gun 70°C for basecoat, equipped with air regulator.

Ref. 60150/BP



- 40-50 cm blow distance in the first phase; - 10-20 cm in final drying.
- Body: metallic
- Nozzle: nylon and rubber radial
- Air consumption: 265 l/min to 3 bar
- Weight: 300 g



Ecodry stand

Aluminium support with 2 Ecodry light - D plug

Ref. 60165

Aluminium support with 2 Ecodry light - JP plug

Ref. 60165/JP



Ecodry stand dries any type of surface from 1 m distance.

- Features: zinc steel structure, 4 anodized aluminum sustaining axis, adjustable.
- Fittings: X 300 U- X400
- Hose: poliurethane spirial hose
- Package: 1 pcs
- Dimensions cm: L 1.60 x P 0.80 x H 2.50 m
- Weight: 9.1 Kg



SPRAY GUN CLEANER

The EASY series spray gun cleaners are used to manually clean spray guns and are the best and most convenient solution for those who want to create an area dedicated to spray gun cleaning.

Practical, essential and complete, the EASY gun cleaners are available in the /S versions for solvent paints and /W versions for water-based paints.

Spraygun cleaner EASY, it allows a proper cleaning and maintenance of your spraygun, really practical and safe, it helps to maintain your spraygun properly and ecofriendly.

The powerful thinner atomizer (water atomizer in the /W version), combines with proper operation, allow for the best results in spraygun clean and maintenance.

Always use protective gloves during cleaning

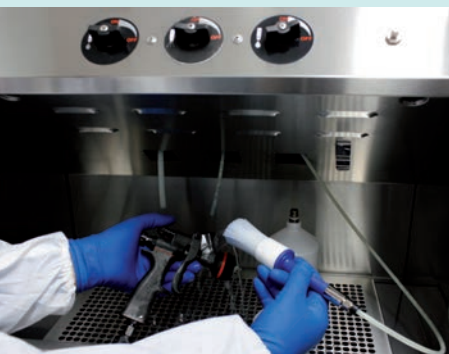
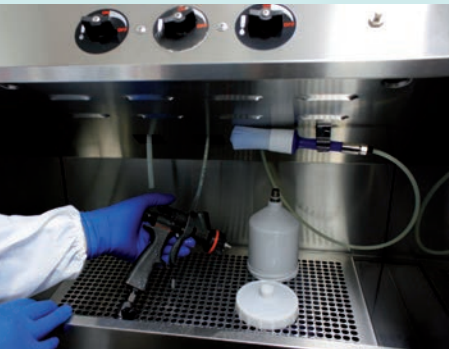

- 1 EXHAUST HOOD**
This guarantees the absence of solvent and other fumes, additionally protecting the operator's health.
- 2 FLOW CHANNELS**
Ecological and efficient, they work with the Venturi and gravity systems.
- 3 WORK SURFACE**
Ample and secure, it provides for efficient and fast work.
- 4 BLOW GUN**
To assist the operator in the spray gun cleaning phases.



SPRAY GUN CLEANER

TYPE

ITEM ID

RECOMMENDED USE

Easy/S

Spray gun cleaner for solvent paints.

Ref. 90061



For more accurate spray gun cleaning in three phases:

- 1) atomized clean solvent flow
- 2) clean solvent flow
- 3) recycled solvent flow

- Structure: zinc sheet
- Dimension of washing tank: L 62 x P 40 x H 50 cm
- Total dimensions cm: L 62 x P 40 x H 140 cm
- Operating air pressure: 4.0-6.0 bar
- Air consumption: 65 l/min.
- Package: 1 pcs
- Weight: 38 Kg



Easy/W

Manual gun cleaner suited for water-based paints.

Ref. 90062



For more accurate spray gun cleaning in three phases:

- 1) atomised clean water flow
- 2) clean water flow
- 3) recycled water flow

- Structure: stainless steel
- Cleaning tank: stainless steel
- Dimension of washing tank: L 55 x P 33 x H 20 cm
- Total dimensions cm: L 68 x P 41 x H 140 cm
- PA/6 cleaning assistant blow gun
- Operating air pressure: 4.0-6.0 bar
- Air consumption: 65 l/min.
- Package: 1 pcs
- Weight: 43 Kg



COMPRESSED AIR GUNS

Complete range of compressed air guns for efficiency and long term professional use in the body-shop workshop. From standard air compressed guns to those for mono-component soundproofing protective compounds, all are manufactured with a MOPLEN body and the components are produced in brass and stainless steel. The new adjustable nozzle of the IAVL - FG allows to obtain different spray thickness according to the surface to be treated.



- 1 **NOZZLE**
External mixing nozzle for event powder product distribution on the surface to be treated.
- 2 **TANK**
Anodised aluminium tank for 1 l cans or cartridges with any thread.
- 3 **REGULATOR**
Inlet air flow regulator to adjust the finish during work.
- 4 **SAFETY VALVE**
Safety valve to permit the automatic release of any over-pressure.

TYPE

ITEM ID

RECOMMENDED USE

IM BODY

Protective soundproof application gun for under bodies, single components and protective waxes, equipped with a product flow regulator and inlet air flow regulator.

Ref. 50242/W

- Nozzle: 1 short nozzle with fan
3 different types of atomising nozzles with 90 cm extensions
- Tank: in anodized aluminium with internal thread cartridge holder and aluminium suction tube.
- Operating air pressure: 5.0 - 8.0 bar
- Package: 1 pcs
- Weight: 2.1 Kg



COMPRESSED AIR GUNS

TYPE

ITEM ID

RECOMMENDED USE

AS/FG

Professional blow gun with flow delivery valve.

Ref. 40004/W



- Body: moplen
- Ugello: ottone nichelato
- Nozzle: nickel-plated brass
- Package: 1 pcs
- Weight: 200 g



PC/NS-FG

Gun for applying adhesives, fillers and silicone in cartridges.

Ref. 30038



- Body: moplen
- Tank: aluminium
- Operating air pressure: 2.0 - 2.5 bar
- Package: 1 pcs
- Cartridge: L 22.5 cm - diam. min Ø 40 - diam. max Ø 50
- Weight: 575 g



IA/L - FG

Gun for applying monocomponent soundproofing protective compounds and protective wax polyurethane bases in 1 l tins.

Ref. 30022**

- | | |
|---|---|
| <ul style="list-style-type: none"> • Body: moplen • Nozzle: adjustable spray • Length of suction tube: 23 cm • Operating air pressure: 2.0 - 2.5 bar • Package: 1 pcs • Weight: 260 g | <ul style="list-style-type: none"> • Connector: with European thread (Ref. 30022) with USA thread (** Ref. 30022USA) with Southamerican thread (** Ref. 30022AM) |
|---|---|



IA/LU - FG

Gun for applying monocomponent soundproofing protective compounds and protective wax polyurethane bases in pre-packed tins. Ref. 30023**

- | | |
|--|--|
| <ul style="list-style-type: none"> • Body: moplen • Featuring: 2 suction tubes, 1 tube with special nozzle for spraying inside parts • Nozzle: adjustable spray • Operating air pressure: 2.0 - 2.5 bar • Package: 1 pcs • Weight: 300 g | <ul style="list-style-type: none"> • Connector: with European thread (Ref. 30023) with USA thread (** Ref. 30023USA) with Southamerican thread (** Ref. 30023AM) • Length of suction tube: 23 cm • Length extension tube: 60 cm |
|--|--|



TS

Gun for applying single component soundproofing protective compounds including polyurethane based compounds and protective waxes in pre-packed 1 l tins.

- Body: polished and nickel-plated metal with soft-touch rubber overprinting
- Featuring: 60 cm long extension tube with special nozzle for spraying in box sections
- Operating air pressure: 2.0 - 2.5 bar
- Package: 1 pcs
- Weight: 540 g
- Connector: with European thread (Ref. 50244/W)
- with USA thread (Ref. 50245/W)
- with Southamerican thread (Ref. 50244AM/W)



General sales conditions

Validity

The following standardised general sales conditions govern the sales agreements, and are integral part of our agreements even when orders are collected by fax, by phone, by e-mail, via internet or verbally.

The provisions, the conditions and any other incidental contractual negotiations, in the case they depart from these general conditions, must be stated and accepted in written, otherwise they will be invalid and without effectiveness.

This catalogue cancels and replaces the previous ones and it may be changed at any time without notice and without this entails any right by the Customers to receive compensation.

Offers and Finalisation of the Contract

Technical descriptions and pictures are reported purely as an indication of the characteristic of the product, but they are not in themselves promises or essential quality of the supplied Products and therefore they may be changed at any time up to the finalisation of the contract.

Requests for quotations (Offers) are not in any case a "confirmed sales order". Further to said requests, Walmec S.p.A. will proceed exclusively in order to provide the required information.

Offers made by Walmec S.p.A. are not binding for the seller. The order made by the customer is binding and irrevocable according to article 1329 Italian Civil Code and for a period of 8 (eight) days after its receipt. Walmec S.p.A. has the right to accept the order either by written confirmation or by starting the execution of the contract, by shipping the ordered Products. The contract is believed to be finalised at Walmec S.p.A.'s commercial offices, via Trieste 10, Santa Lucia di Piave, Treviso, Italy. All orders transmitted are always to be considered "subject to approval" by Walmec S.p.A.

Orders for a total value lower than EUR 500.00 (five-hundred/00) are not accepted, except in the case of orders made solely for spare parts which will only be despatched on cash in advance with carried prepaid.

Prices and Terms of Payment

Unless otherwise written agreement entered by the Parties, Walmec S.p.A. applies to the finalised contract prices quoted on its catalogues and on its price lists effective at the time of the receiving of the order. Prices are quoted net of V.A.T. due according to the Italian Law in force.

Title of Products sold is of Walmec S.p.A. until the full and total payment, and any down payment made will be retained as reimbursement of damages and expenses.

Invoices issued by Walmec S.p.A. must be settled within the written terms agreed by the Parties, at the creditor's domicile, according to Article 1182 Italian Civil Code, even if the payment is made by bill of exchange or cash order.

Being expired the stated payment term, Walmec S.p.A. is authorised to draw a bill without any notice.

In case of late payment beyond the terms agreed and specified on the invoice, interest will be charged and it will be equal to the legal interest rate increased by seven points and related expenses.

In case of late payment Walmec S.p.A. has the right to require the fulfilment of any pending order by asking either advance payment or cash on delivery.

Freight charges will be accrued on the invoice except different agreement by the Parties. Packaging is billed at cost and it is not accepted in return.

Delivery Terms

Walmec S.p.A., in case of orders of remarkable quantity, has the option to make partial delivery.

Delivery terms are never binding; a possible missed delivery either fully or partially, or a simple delay, does not constitute right to recover any damage unless it was explicitly agreed in written form and accepted by the Parties.

In case the Parties have written agreed the Customer will make a down payment, the delivery term starts from the receipt of the agreed sum.

Shipping Risks

Products are shipped with all the risks in charge of the Customer, even if the Products are sold free domicile. Unless otherwise agreed by the Parties in written form, Walmec S.p.A. ships the Products to the address indicated by the Customers.

If the shipment is delayed because of reasons attributable to the customer, the risk in the title or for deterioration of the Products is in charge of the customer starting from the day when Walmec S.p.A. informs the customer to be ready to the shipment of the Products.

In all cases of force-majeure events, such as strikes, stoppage of transport, etc., Walmec S.p.A. will be exempted by its duty concerning the shipment, whereas such events could not be claimed by the customer as reason to annul the order.

Walmec S.p.A. will not bear any responsibility for any possible shortage of materials or damages of the parcels due to shipment made using parcels or train package. We advise our customers to check the quantity of the goods and the shipment conditions before taking delivery of the Products.

Title Retention Agreement

Walmec S.p.A. has the title on the supplied Products up to the integral payment of the due amount and of any other sum due by the Customer for any reason.

Risks and responsibility related to the use of the supplied Products are in charge of the customer starting from the time of the delivery.

Guarantee for Product Defects

The customer, at the time of the delivery, has the burden to check if the supplied Products match with the submitted order both in quantity and quality and if they are free from defects noticed with a quick view using the normal diligence.

Complaints for damages caused by the transport shall be sent directly to the carrier at the time of the receiving of the Product by specific note on the forwarding agent's delivery note, giving notice to Walmec S.p.A. within and not later than 8 (eight) days. Being expired said term, products are considered received and accepted.

Walmec S.p.A. guarantees the conformity of the supplied Products according to what is reported in the catalogue. Products supplied are covered by 12 (twelve) months warranty period, starting from the delivery date, against construction and material defects. In any case the guarantee is not applicable if the customer is not able to prove having made a correct use, maintenance and preservation of the Products.

Walmec S.p.A. denies any liability for damages to persons, animals and things due to an inaccurate and improper use of the Products.

Repairs

Shipments for repairs must be delivered carriage paid to Walmec premises located in via Trieste 10, Santa Lucia di Piave, Treviso, Italy, and will be sent back DDU charging the freight costs on the invoice. Repairs made during the warranty period will be sent back DDU.

Applicable Law and Jurisdiction

Any dispute arising in connection with the present contract shall be finally settled in front of the Treviso Court. This contract is governed by the Italian Law.

WALMEC SPA
WALMEC ITALY HEADQUARTERS

VIA TRIESTE 10, 31025 - S.LUCIA DI PIAVE - (TV) - ITALY
TEL +39 0438 6611
FAX: +39 0438 661333
E-MAIL: WALMEC@WALMEC.COM
WEB: WWW.WALMEC.COM

PRODUCTION PLANT

VIALE DELLA VITTORIA 33, 24054 - CALCIO - (BG) - ITALY

